

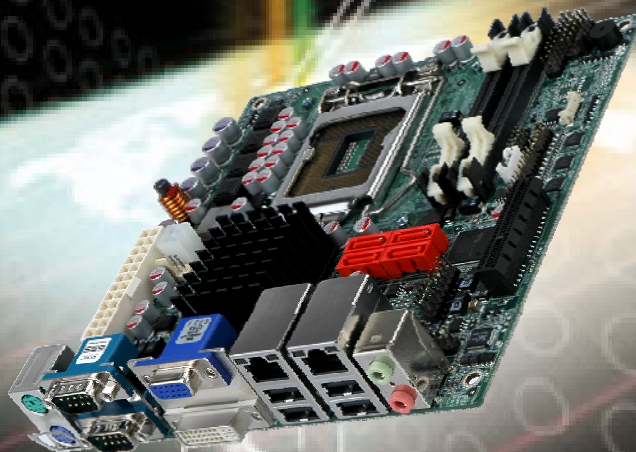

IEI Technology Corp.



**MODEL:
KINO-AH612**

Mini-ITX SBC Supports LGA1155 for Intel® Core™ i7/i5/i3/Pentium®/Celeron® CPU, DDR3, A VGA/DVI-D, Dual PCIe GbE, Eight USB 2.0, Four SATA 3Gb/s, HD Audio and RoHS

User Manual

Rev. 1.01 - 31 January, 2013



Revision

Date	Version	Changes
31 January, 2013	1.01	Updated pinouts for the Digital I/O and RS-422/485 serial port connectors
23 February, 2012	1.00	Initial release

Copyright

COPYRIGHT NOTICE

The information in this document is subject to change without prior notice in order to improve reliability, design and function and does not represent a commitment on the part of the manufacturer.

In no event will the manufacturer be liable for direct, indirect, special, incidental, or consequential damages arising out of the use or inability to use the product or documentation, even if advised of the possibility of such damages.

This document contains proprietary information protected by copyright. All rights are reserved. No part of this manual may be reproduced by any mechanical, electronic, or other means in any form without prior written permission of the manufacturer.

TRADEMARKS

All registered trademarks and product names mentioned herein are used for identification purposes only and may be trademarks and/or registered trademarks of their respective owners.

Table of Contents

1 INTRODUCTION.....	1
1.1 INTRODUCTION.....	2
1.2 CONNECTORS	3
1.3 DIMENSIONS.....	4
1.4 DATA FLOW	5
1.5 TECHNICAL SPECIFICATIONS	6
2 UNPACKING	8
2.1 ANTI-STATIC PRECAUTIONS	9
2.2 UNPACKING PRECAUTIONS.....	9
2.3 PACKING LIST.....	10
2.4 OPTIONAL ITEMS	11
3 CONNECTORS	13
3.1 PERIPHERAL INTERFACE CONNECTORS.....	14
3.1.1 KINO-AH612 Layout	14
3.1.2 Peripheral Interface Connectors	15
3.1.3 External Interface Panel Connectors.....	16
3.2 INTERNAL PERIPHERAL CONNECTORS	16
3.2.1 ATX Power Supply Connector	16
3.2.2 Audio Connector	17
3.2.3 Battery Connector.....	18
3.2.4 BIOS Update Connector	19
3.2.5 DDR3 SO-DIMM Slots	20
3.2.6 Digital I/O Connector.....	20
3.2.7 Fan Connector (CPU).....	21
3.2.8 Fan Connector (System)	22
3.2.9 Front Panel Connector	22
3.2.10 I2C Connector.....	23
3.2.11 Keyboard/Mouse Connector.....	24
3.2.12 PCIe x4 Slot	25

KINO-AH612

3.2.13	<i>Power Connector</i>	26
3.2.14	<i>SATA Drive Connectors</i>	27
3.2.15	<i>Serial Port Connector (RS-232)</i>	27
3.2.16	<i>Serial Port Connector (RS-422/RS-485)</i>	28
3.2.17	<i>SMBus Connector</i>	29
3.2.18	<i>TPM Connector</i>	30
3.2.19	<i>USB Connector</i>	31
3.3	EXTERNAL PERIPHERAL INTERFACE CONNECTOR PANEL	32
3.3.1	<i>Audio Connector</i>	33
3.3.2	<i>Ethernet and USB Connector</i>	33
3.3.3	<i>Keyboard and PS/2 Mouse Connector</i>	34
3.3.4	<i>Serial Port Connector</i>	35
3.3.5	<i>DVI-D + VGA Connector</i>	36
4	INSTALLATION	38
4.1	ANTI-STATIC PRECAUTIONS	39
4.2	INSTALLATION CONSIDERATIONS	40
4.3	BASIC INSTALLATION	41
4.3.1	<i>Socket LGA1155 CPU Installation</i>	41
4.3.2	<i>Cooling Kit Installation</i>	44
4.3.3	<i>DIMM Installation</i>	46
4.4	JUMPER SETTINGS	47
4.4.1	<i>AT/ATX Mode Select Jumper</i>	47
4.4.2	<i>Clear CMOS Jumper</i>	48
4.5	INTERNAL PERIPHERAL DEVICE CONNECTIONS	49
4.5.1	<i>SATA Drive Connection</i>	49
4.6	EXTERNAL PERIPHERAL INTERFACE CONNECTION	51
4.6.1	<i>Audio Connection</i>	51
4.6.2	<i>DVI Connection</i>	52
4.6.3	<i>LAN Connection</i>	53
4.6.4	<i>USB Connection</i>	54
4.6.5	<i>VGA Monitor Connection</i>	55
5	BIOS SCREENS	57
5.1	INTRODUCTION	58

5.1.1 Starting Setup.....	58
5.1.2 Using Setup.....	58
5.1.3 Getting Help.....	59
5.1.4 Unable to Reboot after Configuration Changes.....	59
5.1.5 BIOS Menu Bar.....	59
5.2 MAIN.....	60
5.3 ADVANCED.....	61
5.3.1 ACPI Configuration.....	62
5.3.2 Trusted Computing.....	63
5.3.3 CPU Configuration.....	64
5.3.4 SATA Configuration.....	66
5.3.5 Intel TXT(LT) Configuration.....	67
5.3.6 USB Configuration.....	68
5.3.7 Super IO Configuration.....	69
5.3.8 H/W Monitor.....	75
5.3.9 Serial Port Console Redirection.....	81
5.3.10 IEI Feature.....	81
5.4 CHIPSET.....	83
5.4.1 Northbridge Configuration.....	84
5.4.2 Southbridge Configuration.....	86
5.4.3 Integrated Graphics.....	89
5.5 BOOT.....	90
5.6 SECURITY.....	92
5.7 SAVE & EXIT.....	93
6 SOFTWARE DRIVERS.....	95
6.1 AVAILABLE SOFTWARE DRIVERS.....	96
6.2 SOFTWARE INSTALLATION.....	96

List of Figures

Figure 1-1: KINO-AH612.....	2
Figure 1-2: Connectors (Front Side).....	3
Figure 1-3: KINO-AH612 Dimensions (mm)	4
Figure 1-4: Data Flow Diagram.....	5
Figure 3-1: Connector and Jumper Locations (Front Side)	14
Figure 3-2: ATX Power Supply Connector Location	17
Figure 3-3: Audio Connector Location	18
Figure 3-4: Battery Connector Location.....	19
Figure 3-5: BIOS Update Connector Location	19
Figure 3-6: DDR3 SO-DIMM Slot Locations	20
Figure 3-7: Digital I/O Connector Location	21
Figure 3-8: CPU Fan Connector Location	21
Figure 3-9: System Fan Connector Location.....	22
Figure 3-10: Front Panel Connector Location	23
Figure 3-11: I2C Connector Pinout Location	24
Figure 3-12: Keyboard/Mouse Connector Location	25
Figure 3-13: PCIe x4 Slot Location	26
Figure 3-14: Power Connector Location	26
Figure 3-15: SATA Drive Connector Locations	27
Figure 3-16: RS-232 Serial Port Connector Locations.....	28
Figure 3-17: RS-424/RS-485 Serial Port Connector Locations	29
Figure 3-18: SMBus Connector Location	30
Figure 3-19: TPM Connector Location.....	31
Figure 3-20: USB Connector Locations.....	32
Figure 3-21: KINO-AH612 External Peripheral Interface Connector.....	33
Figure 3-22: Audio Connector	33
Figure 3-23: LAN Connector.....	34
Figure 3-24: Serial Port Pinouts	36
Figure 3-25: VGA Connector	36
Figure 4-1: Disengage the CPU Socket Load Lever.....	42
Figure 4-2: Remove Protective Cover.....	42

Figure 4-3: Insert the Socket LGA1155 CPU.....	43
Figure 4-4: Close the Socket LGA1155	44
Figure 4-5: Cooling Kits (CF-1156A-RS, CF-1156B-RS, CF-1156C-RS, CF-1156D-RS).....	44
Figure 4-6: Cooling Kit Support Bracket.....	45
Figure 4-7: DIMM Installation.....	46
Figure 4-8: Jumper Locations	47
Figure 4-9: AT/ATX Mode Select Jumper Location	48
Figure 4-10: Clear CMOS Jumper Location	49
Figure 4-11: SATA Drive Cable Connection.....	50
Figure 4-12: SATA Power Drive Connection.....	51
Figure 4-13: Audio Connector	52
Figure 4-14: DVI Connector	53
Figure 4-15: LAN Connection	54
Figure 4-16: USB Connector.....	55
Figure 4-17: VGA Connector	56
Figure 6-1: Introduction Screen	97
Figure 6-2: Available Drivers	97
Figure B-1: IEI One Key Recovery Tool Menu	102
Figure B-2: Launching the Recovery Tool	107
Figure B-3: Recovery Tool Setup Menu	107
Figure B-4: Command Prompt	108
Figure B-5: Partition Creation Commands.....	109
Figure B-6: Launching the Recovery Tool	111
Figure B-7: Manual Recovery Environment for Windows	111
Figure B-8: Building the Recovery Partition.....	112
Figure B-9: Press Any Key to Continue	112
Figure B-10: Press F3 to Boot into Recovery Mode.....	113
Figure B-11: Recovery Tool Menu	113
Figure B-12: About Symantec Ghost Window.....	114
Figure B-13: Symantec Ghost Path	114
Figure B-14: Select a Local Source Drive	115
Figure B-15: Select a Source Partition from Basic Drive	115
Figure B-16: File Name to Copy Image to	116
Figure B-17: Compress Image.....	116
Figure B-18: Image Creation Confirmation	117

KINO-AH612

Figure B-19: Image Creation Complete	117
Figure B-20: Image Creation Complete	117
Figure B-21: Press Any Key to Continue	118
Figure B-22: Auto Recovery Utility	119
Figure B-23: Disable Automatically Restart.....	119
Figure B-24: Launching the Recovery Tool	120
Figure B-25: Auto Recovery Environment for Windows	120
Figure B-26: Building the Auto Recovery Partition.....	121
Figure B-27: Factory Default Image Confirmation	121
Figure B-28: Image Creation Complete	122
Figure B-29: Press any key to continue	122
Figure B-30: Partitions for Linux.....	124
Figure B-31: Manual Recovery Environment for Linux	125
Figure B-32: Access menu.lst in Linux (Text Mode).....	125
Figure B-33: Recovery Tool Menu	126
Figure B-34: Recovery Tool Main Menu	127
Figure B-35: Restore Factory Default.....	128
Figure B-36: Recovery Complete Window	128
Figure B-37: Backup System.....	129
Figure B-38: System Backup Complete Window	129
Figure B-39: Restore Backup	130
Figure B-40: Restore System Backup Complete Window	130
Figure B-41: Symantec Ghost Window	131
Figure B-42: Disable Automatically Restart.....	138

List of Tables

Table 1-1: Technical Specifications.....	7
Table 3-1: Peripheral Interface Connectors.....	15
Table 3-2: Rear Panel Connectors.....	16
Table 3-3: ATX Power Supply Connector Pinouts.....	17
Table 3-4: Audio Connector Pinouts.....	18
Table 3-5: Battery Connector Pinouts.....	19
Table 3-6: BIOS Update Connector Pinouts.....	20
Table 3-7: Digital I/O Connector Pinouts.....	21
Table 3-8: CPU Fan Connector Pinouts.....	22
Table 3-9: System Fan Connector Pinouts.....	22
Table 3-10: Front Panel Connector Pinouts.....	23
Table 3-11: I2C Connector Pinouts.....	24
Table 3-12: Keyboard/Mouse Connector Pinouts.....	25
Table 3-13: Power Connector Pinouts.....	26
Table 3-14: SATA Drive Connector Pinouts.....	27
Table 3-15: RS-232 Serial Port Connector Pinouts.....	28
Table 3-16: RS-422/RS-485 Serial Port Connector Pinouts.....	29
Table 3-17: SMBus Connector Pinouts.....	30
Table 3-18: TPM Connector Pinouts.....	31
Table 3-19: USB Connector Pinouts.....	32
Table 3-20: LAN and USB Connector Pinouts.....	34
Table 3-21: Keyboard PS/2 Connector Pinouts.....	35
Table 3-22: Serial Port Pinouts.....	35
Table 3-23: VGA Connector Pinouts.....	36
Table 3-24: DVI Connector Pinouts.....	37
Table 4-1: Jumpers.....	47
Table 4-2: AT/ATX Mode Select Jumper Settings.....	48
Table 4-3: Clear CMOS Jumper Settings.....	49
Table 5-1: BIOS Navigation Keys.....	59

List of BIOS Menus

BIOS Menu 1: Main	60
BIOS Menu 2: Advanced	62
BIOS Menu 3: ACPI Configuration	62
BIOS Menu 4: TPM Configuration	63
BIOS Menu 5: CPU Configuration	64
BIOS Menu 6: CPU Configuration	65
BIOS Menu 7: IDE Configuration	66
BIOS Menu 8: Intel TXT(LT) Configuration	68
BIOS Menu 9: USB Configuration	68
BIOS Menu 10: Super IO Configuration.....	69
BIOS Menu 11: Serial Port n Configuration Menu	70
BIOS Menu 12: Hardware Health Configuration	76
BIOS Menu 13: FAN 1 Configuration	77
BIOS Menu 14: FAN 2 Configuration	79
BIOS Menu 15: Serial Port Console Redirection Menu.....	81
BIOS Menu 16: IEI Feature	82
BIOS Menu 17: Chipset	83
BIOS Menu 18: Northbridge Chipset Configuration.....	84
BIOS Menu 19: Southbridge Chipset Configuration	87
BIOS Menu 20: Integrated Graphics	89
BIOS Menu 21: Boot	90
BIOS Menu 22: Security	92
BIOS Menu 23: Exit.....	93
BIOS Menu 24: IEI Feature	123

Chapter

1

Introduction

1.1 Introduction



Figure 1-1: KINO-AH612

The KINO-AH612 is a Mini-ITX motherboard. It accepts an LGA1155 Intel® Core™ i7/i5/i3/Pentium®/Celeron® processor and supports two 204-pin 1066/1333 MHz dual-channel DDR3 SO-DIMM modules up to 16 GB.

The integrated Intel® H61 System Chipset supports two GbE LAN ports through dual Realtek RTL8111E PCIe GbE controllers (with ASF 2.0 support). The KINO-AH612 also supports four SATA 3Gb/s drives.

The KINO-AH612 includes a VGA and DVI-D combination port. Expansion and I/O include one PCI x4 slot, four USB 2.0 ports on the rear panel and four USB 2.0 ports by pin header. Serial device connectivity is provided by two external RS-232 connectors.

KINO-AH612

1.2 Connectors

The connectors on the KINO-AH612 are shown in the figure below.

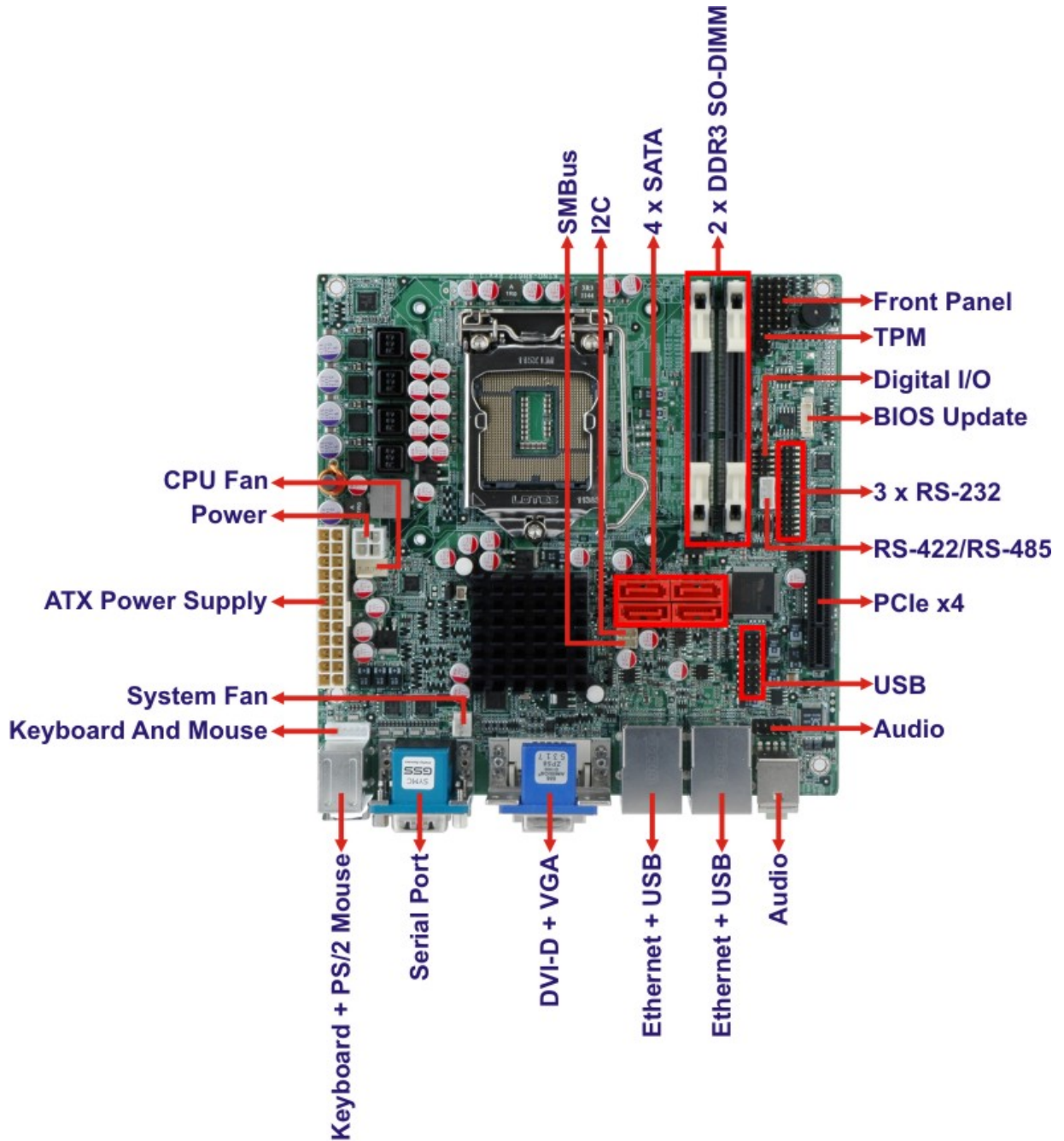

Figure 1-2: Connectors (Front Side)

1.3 Dimensions

The dimensions of the board are listed below:

- **Length:** 170 mm
- **Width:** 170 mm

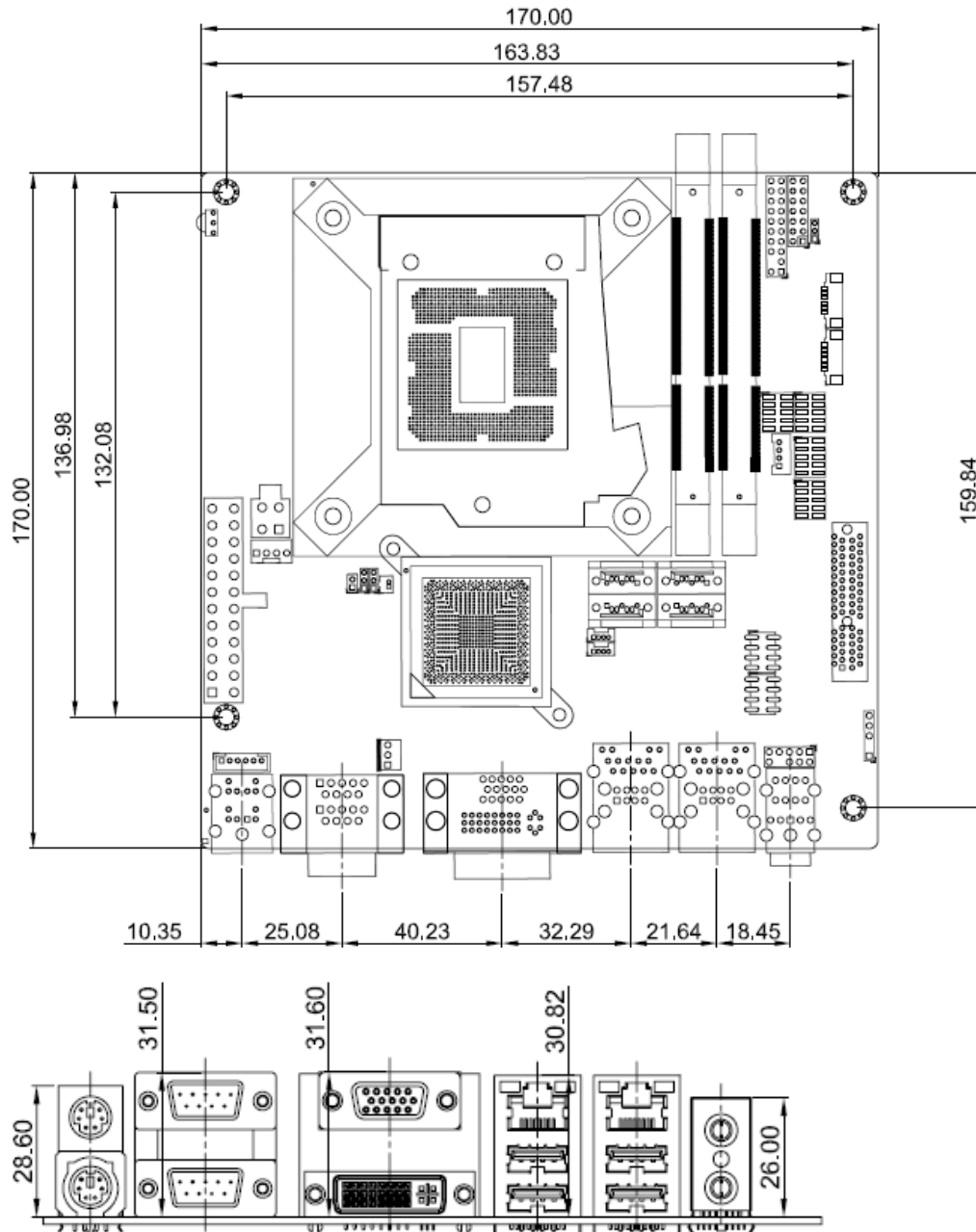

Figure 1-3: KINO-AH612 Dimensions (mm)

KINO-AH612

1.4 Data Flow

Figure 1-4 shows the data flow between the system chipset, the CPU and other components installed on the motherboard.

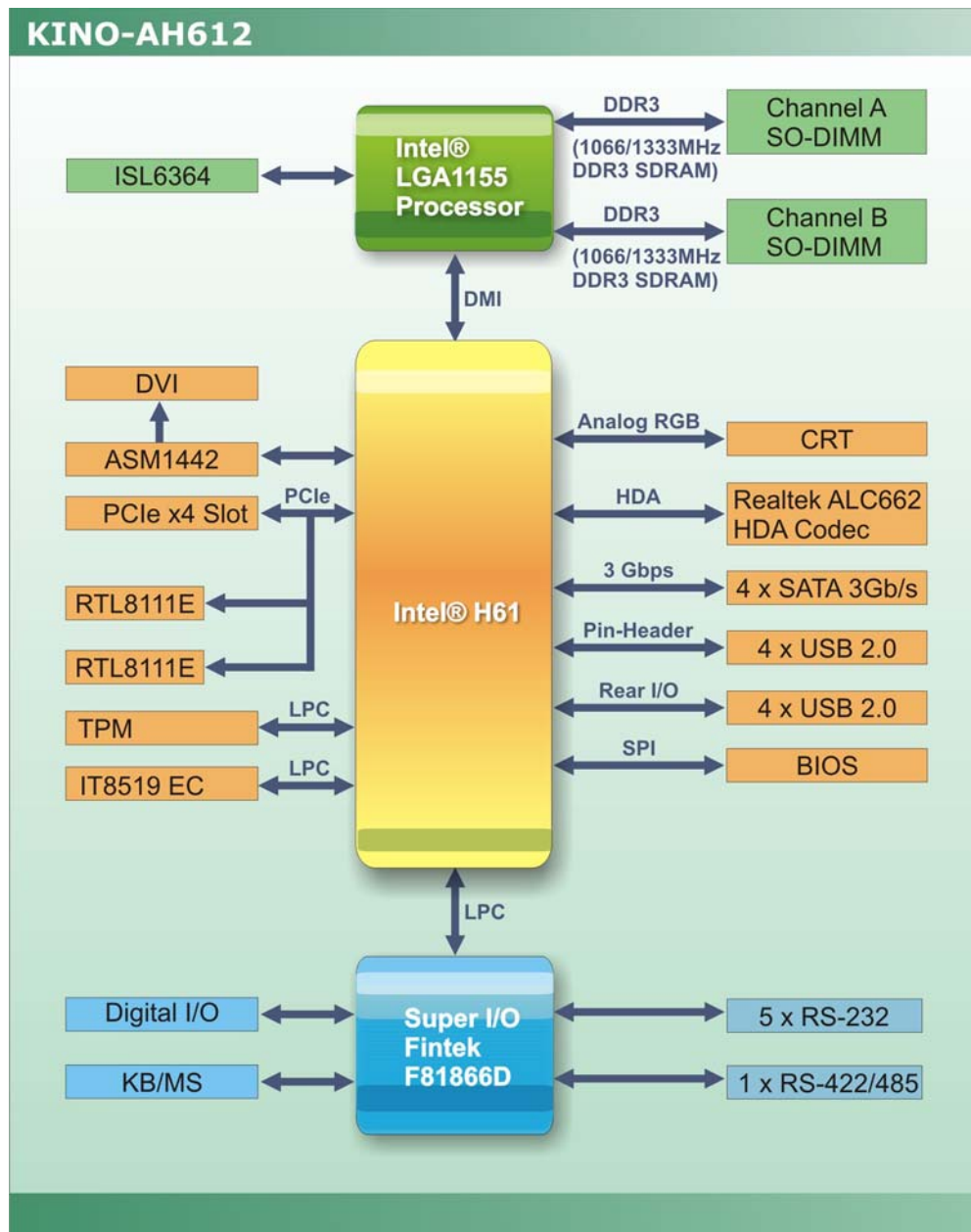

Figure 1-4: Data Flow Diagram

1.5 Technical Specifications

KINO-AH612 technical specifications are listed in table below.

Specification	KINO-AH612
Form Factor	Mini-ITX
Socket	LGA1155
CPU Supported	Socket 1155 Intel® Core™ i7/i5/i3/Pentium®/Celeron® dual core processor
System Chipset	Intel® H61
Memory	Two 204-pin 1066/1333 MHz dual-channel DDR3 SO-DIMM supported (system max. 16 GB)
Graphics Engine	Support for DX10.1 and OpenGL3.0, full MPEG2, VC1, AVC decode
Audio	Realtek ALC662 HD Audio codec
LAN	Two Realtek RTL8111E PCIe GbE controllers with ASF 2.0 support
Embedded Controller	iWDD
Super I/O	Fintek F81866
Digital I/O	8-bit digital I/O, 4-bit input/4-bit output
BIOS	UEFI BIOS
Watchdog Timer	Software programmable supports 1~255 sec. system reset
Expansions	
PCIe	One PCIe x4 slot
I/O Interface Connectors	
Audio Connector	Two external audio jacks (Line-out, Mic)
Display Ports	One VGA integrated in Intel® H61 One DVI-D integrated in Intel® H61
Ethernet	Two RJ-45 GbE ports

KINO-AH612

Specification	KINO-AH612
Keyboard/Mouse	One internal keyboard and mouse connector via 6-pin wafer
TPM	One 20-pin header
Fan	One 4-pin CPU fan connector One 3-pin system fan connector
Serial Ports	One internal RS-422/485 via internal 4-pin wafer
USB Ports	Four external USB 2.0 ports by rear IO Four internal USB 2.0 ports via 8-pin header
Storage	
Serial ATA	Four SATA 3Gb/s connectors
Environmental and Power Specifications	
Power Supply	ATX power supply
Power Consumption	5V@3.9A, 12V@0.36A, Vcore_12V@8.28A, 3.3V@1.24A, 5VSB@0.18A (3.4GHz Intel® Core™ i7-2600 with 2GB*2 DDR3 1333MHz)
Operating Temperature	-10°C ~ 60°C
Storage Temperature	-20°C ~ 70°C
Humidity	5% ~ 95% (non-condensing)
Physical Specifications	
Dimensions	170 mm x 170 mm
Weight GW/NW	1100 g / 700 g

Table 1-1: Technical Specifications

Chapter

2

Unpacking

2.1 Anti-static Precautions



WARNING!

Static electricity can destroy certain electronics. Make sure to follow the ESD precautions to prevent damage to the product, and injury to the user.

Make sure to adhere to the following guidelines:

- **Wear an anti-static wristband:** Wearing an anti-static wristband can prevent electrostatic discharge.
- **Self-grounding:** Touch a grounded conductor every few minutes to discharge any excess static buildup.
- **Use an anti-static pad:** When configuring any circuit board, place it on an anti-static mat.
- **Only handle the edges of the PCB:** Don't touch the surface of the motherboard. Hold the motherboard by the edges when handling.

2.2 Unpacking Precautions

When the KINO-AH612 is unpacked, please do the following:







- Follow the antistatic guidelines above.
- Make sure the packing box is facing upwards when opening.
- Make sure all the packing list items are present.

2.3 Packing List



NOTE:

If any of the components listed in the checklist below are missing, do not proceed with the installation. Contact the IEI reseller or vendor the KINO-AH612 was purchased from or contact an IEI sales representative directly by sending an email to sales@iei.com.tw.

The KINO-AH612 is shipped with the following components:

Quantity	Item and Part Number	Image
1	KINO-AH612 motherboard	
2	SATA cable (P/N: 32000-062800-RS)	
1	Dual RS-232 Cable (P/N: 19800-000112-RS)	
1	I/O shielding (P/N: 45014-0008C0-00-RS)	
1	Mini jumper pack (2.0mm)	
1	Utility CD	



KINO-AH612

1	One Key Recovery CD	
1	Quick Installation Guide	

2.4 Optional Items

The following are optional components which may be separately purchased:

Item and Part Number	Image
Dual-port USB cable with bracket (P/N: 19800-003100-200-RS)	
SATA power cable (P/N: 32102-000100-200-RS)	
High-performance LGA1155/LGA1156 cooler kit, 1U chassis compatible, 73W (P/N: CF-1156A-RS)	
High-performance LGA1155/LGA1156 cooler kit, 95W (P/N: CF-1156B-RS)	
LGA1155/LGA1156 cooler kit, 1U Chassis compatible, 45W (P/N: CF-1156C-RS)	

<p>LGA1155/LGA1156 cooler kit, 1U Chassis compatible, 65W (P/N: CF-1156D-RS)</p>	
<p>20-pin Infineon TPM module, software management tool, firmware V3.17 (P/N: TPM-IN01-R11)</p>	
<p>SATA to CF converter board (P/N: SACF-KIT01-R10)</p>	
<p>Intel® Core™ i5-2500T processor, LGA1155, quad core 2.3GHz, 6M cache, 45W, compatible with CF-1156C-RS CPU cooler (P/N: CPU-DT-i5-2500T)</p>	
<p>Intel® Core™ i5-2390T processor, LGA1155, dual core 2.7GHz, 3M cache, 35W, AMT, compatible with CF-1156C-RS CPU cooler (P/N: CPU-DT-i5-2390T)</p>	
<p>Intel® Core™ i3-2100T processor, LGA1155, dual core 2.5GHz, 3M cache, 35W, compatible with CF-1156C-RS CPU cooler (P/N: CPU-DT-i3-2100T)</p>	
<p>Intel® Pentium G620T processor, LGA1155, dual core 2.2GHz, 3M cache, 35W, compatible with CF-1156C-RS CPU cooler (P/N: CPU-DT-P-G620T)</p>	
<p>Intel® Celeron G440 processor, LGA1155, single core 1.6GHz, 1M cache, 35W, compatible with CF-1156C-RS CPU cooler (P/N: CPU-DT-C-G440)</p>	

Chapter

3

Connectors

3.1 Peripheral Interface Connectors

This chapter details all the jumpers and connectors.

3.1.1 KINO-AH612 Layout

The figures below show all the connectors and jumpers.

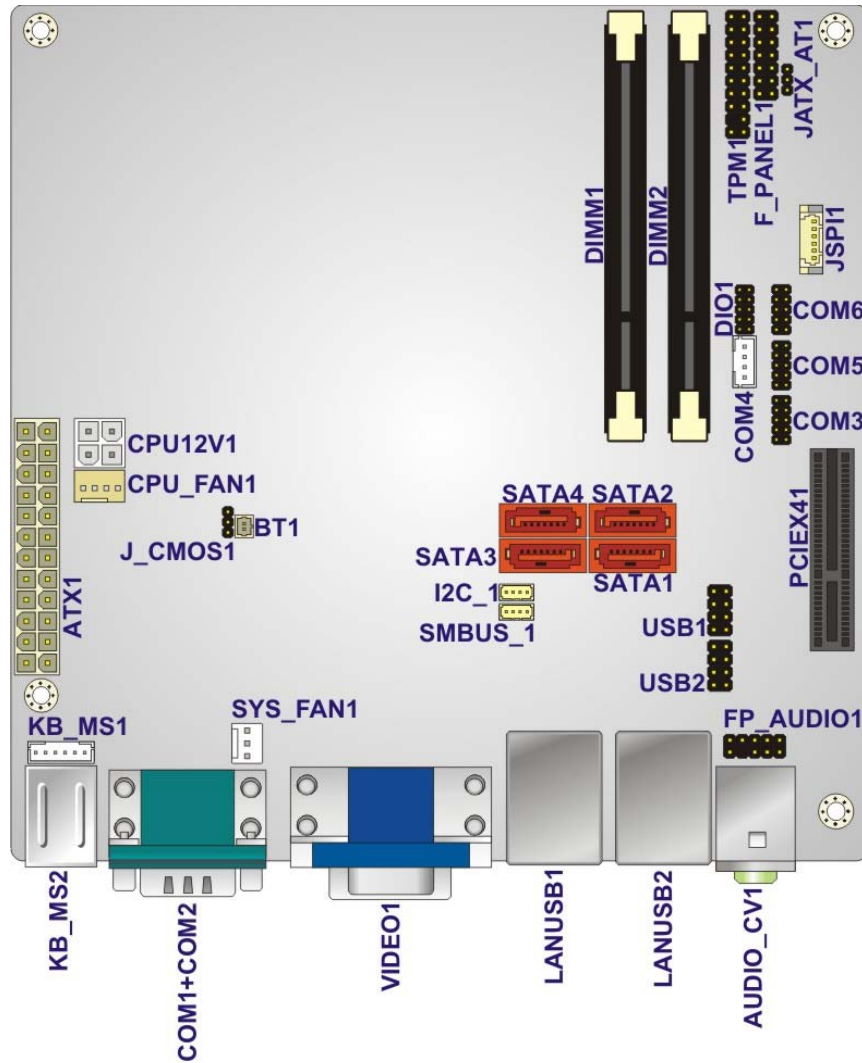

Figure 3-1: Connector and Jumper Locations (Front Side)

3.1.2 Peripheral Interface Connectors

The following table lists all the connectors on the board.

Connector	Type	Label
ATX power supply	24-pin ATX	ATX1
Audio connector	10-pin header	FP_AUDIO1
Battery connector	2-pin wafer	BT1
BIOS update connector	6-pin header	JSPI1
DDR3 SO-DIMM slots	DDR3 SO-DIMM slot	DIMM1, DIMM2
Digital I/O connector	10-pin header	DIO1
Fan connector (CPU)	4-pin wafer	CPU_FAN1
Fan connector (System)	3-pin wafer	SYS_FAN1
Front Panel connector	14-pin header	F_PANEL
I2C connector	4-pin wafer	I2C_1
Keyboard/mouse connector	6-pin wafer	KB_MS1
PCIe x4 slot	PCIe x4 slot	PCIEX41
Power connector	4-pin connector	CPU_12V
SATA drive connector	Serial ATA (SATA) 3Gb/s Connector	SATA1, SATA2, SATA3, SATA4
Serial port connector (RS-232)	10-pin header	COM3, COM5, COM6
Serial port connector (RS-422/RS-485)	4-pin wafer	COM4
SMBus connector	4-pin wafer	SMBUS_1
TPM connector	20-pin header	TPM1
USB connector	8-pin header	USB1, USB2

Table 3-1: Peripheral Interface Connectors

3.1.3 External Interface Panel Connectors

The table below lists the connectors on the external I/O panel.

Connector	Type	Label
Audio connector	Audio jack	AUDIO_CV1
Ethernet + USB connector	RJ-45, USB port	LANUSB1, LANUSB2
Keyboard and PS/2 Mouse connector	Dual PS/2 port	KB_MS2
Serial port connectors	Dual DB-9 port	COM1, COM2
DVI-D + VGA connector	DVI + 15-pin female	VIDEO1

Table 3-2: Rear Panel Connectors

3.2 Internal Peripheral Connectors

The section describes all of the connectors on the KINO-AH612.

3.2.1 ATX Power Supply Connector

- CN Label:** ATX1
- CN Type:** 24-pin connector
- CN Location:** See **Figure 3-2**
- CN Pinouts:** See **Table 3-3**

The ATX power connector connects to an ATX power supply.

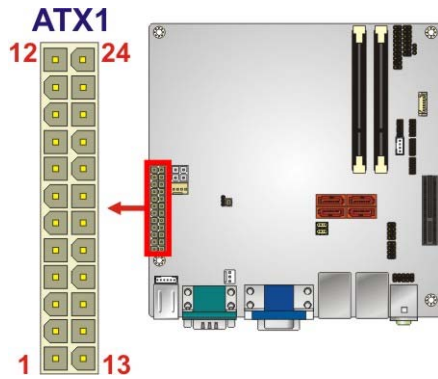

Figure 3-2: ATX Power Supply Connector Location

PIN NO.	DESCRIPTION	PIN NO.	DESCRIPTION
1	+3.3Vdc	13.	+3.3Vdc
2	+3.3Vdc	14	-12Vdc
3	GND	15	GND
4	+5Vdc	16	PS-ON
5	GND	17	GND
6	+5Vdc	18	GND
7	GND	19	GND
8	PWR-OK	20	-5Vdc (NC)
9	+5VSby	21	+5Vdc
10	+12Vdc	22	+5Vdc
11	+12Vdc	23	+5Vdc
12	+3.3Vdc	24	GND

Table 3-3: ATX Power Supply Connector Pinouts

3.2.2 Audio Connector

- CN Label:** FP_AUDIO1
- CN Type:** 10-pin header
- CN Location:** See Figure 3-3
- CN Pinouts:** See Table 3-4

This connector connects to speakers, a microphone and an audio input.

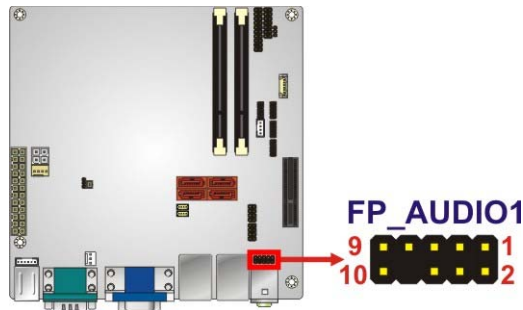

Figure 3-3: Audio Connector Location

Pin	Description	Pin	Description
1	LMIC2_L	2	AUD GND
3	LMIC2_R	4	PRESENCE#
5	LLINE2-R	6	MIC2-JD
7	F_SENSE	8	NC
9	LLINE2-L	10	LINE2-JD

Table 3-4: Audio Connector Pinouts

3.2.3 Battery Connector



CAUTION:

Risk of explosion if battery is replaced by an incorrect type. Only certified engineers should replace the on-board battery.

Dispose of used batteries according to instructions and local regulations.

- CN Label:** BT1
- CN Type:** 2-pin wafer
- CN Location:** See **Figure 3-4**
- CN Pinouts:** See **Table 3-5**

KINO-AH612

This is connected to the system battery. The battery provides power to the system clock to retain the time when power is turned off.

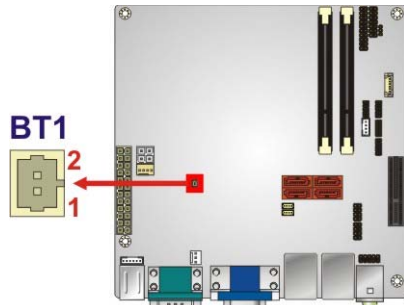

Figure 3-4: Battery Connector Location

Pin	Description
1	Battery+
2	Ground

Table 3-5: Battery Connector Pinouts

3.2.4 BIOS Update Connector

- CN Label:** JSPI1
- CN Type:** 6-pin wafer (1x6)
- CN Location:** See **Figure 3-5**
- CN Pinouts:** See **Table 3-6**

The connector is for BIOS updating.

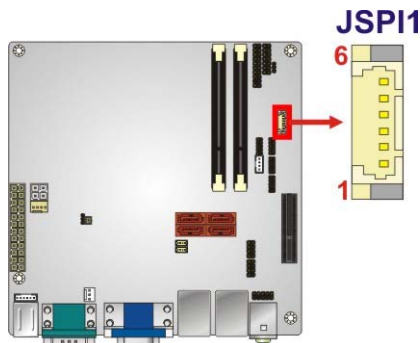

Figure 3-5: BIOS Update Connector Location

PIN NO.	DESCRIPTION	PIN NO.	DESCRIPTION
1	SPI_VCC	2	SPI_CS#
3	SPI_MISO	4	SPI_CLK
5	SPI_MOSI	6	GND

Table 3-6: BIOS Update Connector Pinouts

3.2.5 DDR3 SO-DIMM Slots

- CN Label:** DIMM1, DIMM2
- CN Type:** DDR3 SO-DIMM slot
- CN Location:** See **Figure 3-6**

The DDR3 DIMM slots are for DDR3 SO-DIMM memory modules.

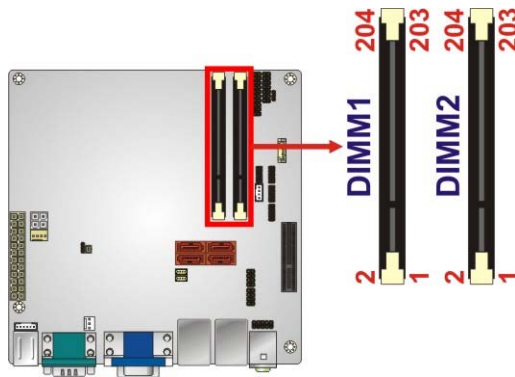

Figure 3-6: DDR3 SO-DIMM Slot Locations

3.2.6 Digital I/O Connector

- CN Label:** DIO1
- CN Type:** 10-pin header (2x5)
- CN Location:** See **Figure 3-7**
- CN Pinouts:** See **Table 3-7**

The digital I/O connector provides programmable input and output for external devices. The digital I/O provides 4-bit output and 4-bit input.

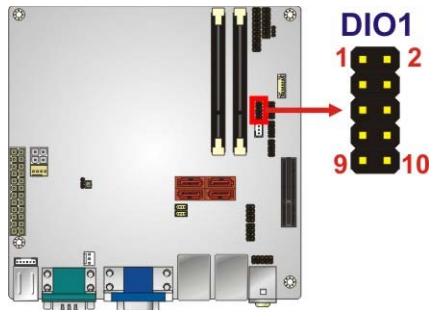

Figure 3-7: Digital I/O Connector Location

PIN NO.	DESCRIPTION	PIN NO.	DESCRIPTION
1	GND	2	+5V
3	DOUT3	4	DOUT2
5	DOUT1	6	DOUT0
7	DIN3	8	DIN2
9	DIN1	10	DINO

Table 3-7: Digital I/O Connector Pinouts

3.2.7 Fan Connector (CPU)

- CN Label:** CPU_FAN1
- CN Type:** 4-pin wafer
- CN Location:** See Figure 3-8
- CN Pinouts:** See Table 3-8

The fan connector attaches to a CPU cooling fan.

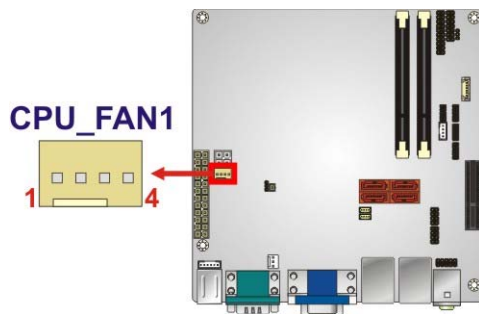

Figure 3-8: CPU Fan Connector Location

PIN NO.	DESCRIPTION	PIN NO.	DESCRIPTION
1	GND	2	+12V
3	FANIO1	4	PWM

Table 3-8: CPU Fan Connector Pinouts

3.2.8 Fan Connector (System)

- CN Label:** **SYS_FAN1**
- CN Type:** 3-pin wafer
- CN Location:** See **Figure 3-9**
- CN Pinouts:** See **Table 3-9**

The fan connector connects to a system cooling fan.

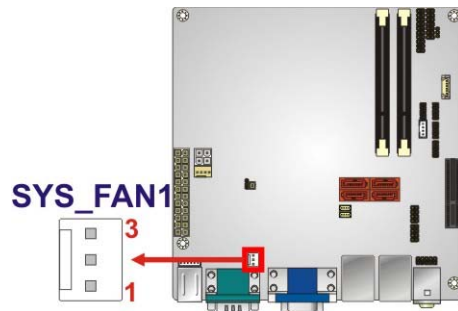
Figure 3-9: System Fan Connector Location

PIN NO.	DESCRIPTION
1	FANIO
2	+12V (PWM)
3	GND

Table 3-9: System Fan Connector Pinouts

3.2.9 Front Panel Connector

- CN Label:** **F_PANEL**
- CN Type:** 14-pin header
- CN Location:** See **Figure 3-10**

KINO-AH612

CN Pinouts: See **Table 3-10**

The front panel connector connects to the indicator LEDs and buttons on the computer's front panel.

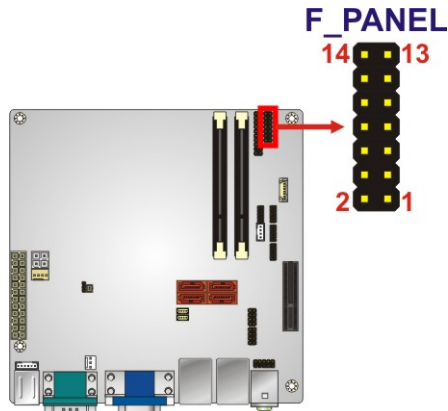

Figure 3-10: Front Panel Connector Location

	PIN NO.	DESCRIPTION	PIN NO.	DESCRIPTION	
PWR_LED	1	ACPILED	2	BEEP_PWR	BUZZER
	3	NC	4	NC	
	5	GND	6	NC	
PWR_BTN	7	PWRBTN_SW#_C	8	PC_BEEP	NC
	9	GND	10	NC	
HDD_LED	11	IDELED	12	EXTRST	RESET
	13	IDELED	14	GND	

Table 3-10: Front Panel Connector Pinouts

3.2.10 I2C Connector

CN Label: I2C_1
CN Type: 4-pin wafer
CN Location: See **Figure 3-11**
CN Pinouts: See **Table 3-11**

The I2C connector is used to connect I2C-bus devices to the mainboard.

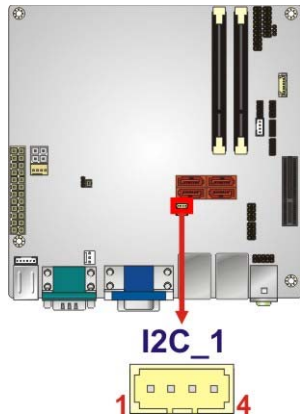

Figure 3-11: I2C Connector Pinout Location

Pin	Description
1	+5V DUAL
2	PCH_GP38_PU
3	PCH_GP39_PU
4	GND

Table 3-11: I2C Connector Pinouts

3.2.11 Keyboard/Mouse Connector

- CN Label:** KB_MS1
- CN Type:** 6-pin wafer
- CN Location:** See **Figure 3-12**
- CN Pinouts:** See **Table 3-12**

The keyboard/mouse connector connects to a PS/2 Y-cable that can be connected to a PS/2 keyboard and mouse.

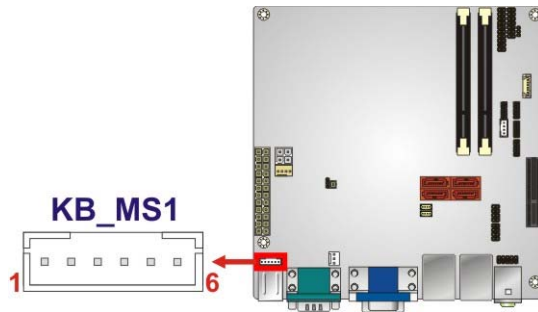

Figure 3-12: Keyboard/Mouse Connector Location

PIN NO.	DESCRIPTION
1	VCC5_KBMS
2	MSDATA
3	MSCLK
4	KBDATA
5	KBCLK
6	KBGND

Table 3-12: Keyboard/Mouse Connector Pinouts

3.2.12 PCIe x4 Slot

CN Label: PCIEX41
CN Type: PCIe x4 slot
CN Location: See **Figure 3-13**

The PCIe x4 slot is for PCIe x4 expansion cards.

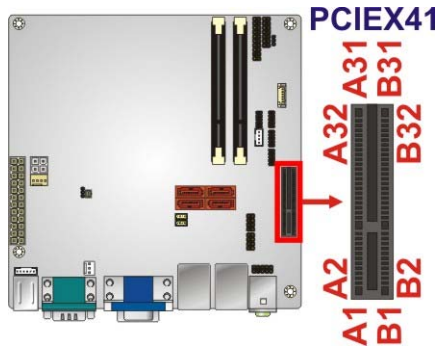

Figure 3-13: PCIe x4 Slot Location

3.2.13 Power Connector

- CN Label:** CPU_12V
- CN Type:** 4-pin connector
- CN Location:** See Figure 3-14
- CN Pinouts:** See Table 3-13

The power connector provides 12 V power to the motherboard.

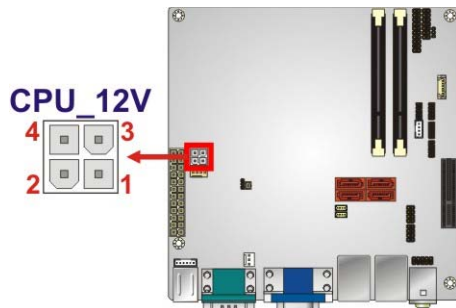

Figure 3-14: Power Connector Location

PIN NO.	DESCRIPTION
1	GND
2	GND
3	+12V
4	+12V

Table 3-13: Power Connector Pinouts

3.2.14 SATA Drive Connectors

- CN Label:** SATA1, SATA2, SATA3, SATA4
- CN Type:** Serial ATA (SATA) 3Gb/s Connector
- CN Location:** See **Figure 3-15**
- CN Pinouts:** See **Table 3-14**

The four SATA 3Gb/s drive connectors are each connected to a SATA 3Gb/s drive. The SATA 3Gb/s drives transfer data at speeds as high as 3Gb/s.

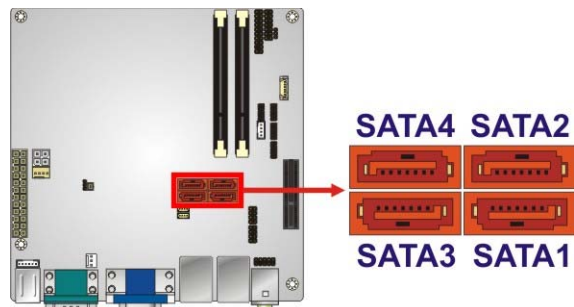

Figure 3-15: SATA Drive Connector Locations

PIN NO.	DESCRIPTION
1	GND
2	TXP
3	TXN
4	GND
5	RXN
6	RXP
7	GND
8	N/C

Table 3-14: SATA Drive Connector Pinouts

3.2.15 Serial Port Connector (RS-232)

- CN Label:** COM3, COM5, COM6
- CN Type:** 10-pin header

CN Location: See Figure 3-16

CN Pinouts: See Table 3-15

This connector provides RS-232 communications.

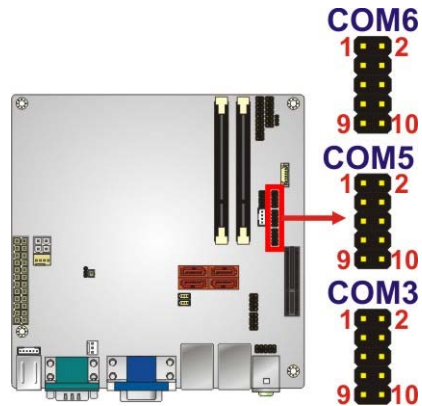

Figure 3-16: RS-232 Serial Port Connector Locations

PIN NO.	DESCRIPTION
1	-NDCD1
2	-NDSR1
3	NSIN1
4	-NRTS1
5	NSOUT1
6	-NCTS1
7	-NDTR1
8	-XRI1
9	GND
10	GND

Table 3-15: RS-232 Serial Port Connector Pinouts

3.2.16 Serial Port Connector (RS-422/RS-485)

CN Label: COM4

CN Type: 4-pin wafer

CN Location: See Figure 3-16

KINO-AH612

CN Pinouts: See **Table 3-15**

This connector provides RS-422 and RS-482 communications.

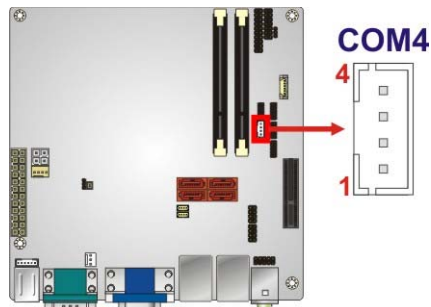

Figure 3-17: RS-424/RS-485 Serial Port Connector Locations

PIN NO.	DESCRIPTION
1	RXD422-
2	RXD422+
3	TXD422+/TXD485+
4	TXD422-/TXD485-

Table 3-16: RS-422/RS-485 Serial Port Connector Pinouts

3.2.17 SMBus Connector

CN Label: **SMBUS_1**

CN Type: 4-pin wafer

CN Location: See **Figure 3-18**

CN Pinouts: See **Table 3-17**

The SMBus (System Management Bus) connector provides low-speed system management communications.

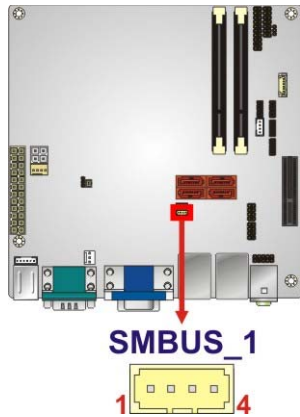

Figure 3-18: SMBus Connector Location

Pin	Description
1	+5V_DUAL
2	SMBCLK
3	SMBDATA
4	GND

Table 3-17: SMBus Connector Pinouts

3.2.18 TPM Connector

- CN Label:** TPM1
- CN Type:** 20-pin header
- CN Location:** See **Figure 3-19**
- CN Pinouts:** See **Table 3-18**

The Trusted Platform Module (TPM) connector secures the system on bootup.

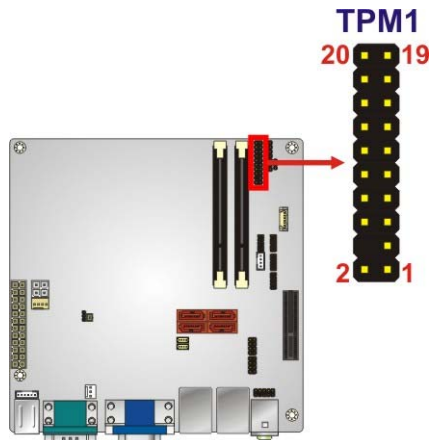

Figure 3-19: TPM Connector Location

PIN NO.	DESCRIPTION	PIN NO.	DESCRIPTION
1	LCLK	2	GND2
3	LERAME#	4	KEY
5	LRESRT#	6	+5V
7	LAD3	8	LAD2
9	+3V	10	LAD1
11	LAD0	12	GND3
13	SCL	14	SDA
15	SB3V	16	SERIRQ
17	GND1	18	GLKRUN#
19	LPCPD#	20	LDRQ#

Table 3-18: TPM Connector Pinouts

3.2.19 USB Connector

- CN Label:** USB1, USB2
- CN Type:** 8-pin header (2x4)
- CN Location:** See Figure 3-20
- CN Pinouts:** See Table 3-19

The USB connectors connect to USB devices. Each pin header provides two USB ports.

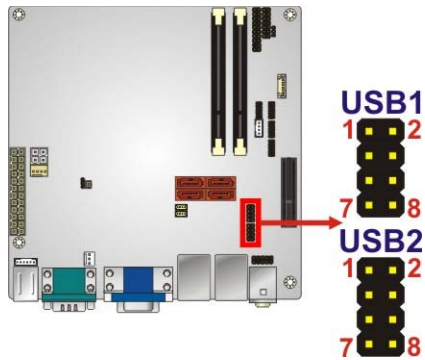

Figure 3-20: USB Connector Locations

PIN NO.	DESCRIPTION	PIN NO.	DESCRIPTION
1	VCC	2	GND
3	DATA-	4	DATA+
5	DATA+	6	DATA-
7	GND	8	VCC

Table 3-19: USB Connector Pinouts

3.3 External Peripheral Interface Connector Panel

Figure 3-21 shows the KINO-AH612 external peripheral interface connector (EPIC) panel.

The EPIC panel consists of the following:

- 2 x Audio jacks
- 1 x VGA connector
- 1 x DVI connector
- 2 x Ethernet connectors
- 4 x USB connectors
- 2 x PS/2 connectors
- 2 x DB-9 serial port connectors

KINO-AH612

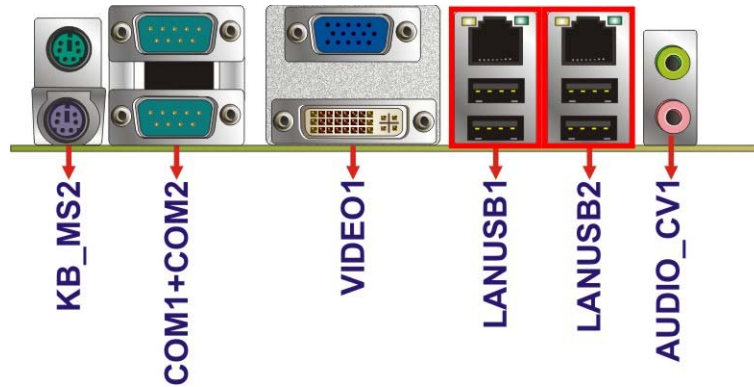

Figure 3-21: KINO-AH612 External Peripheral Interface Connector

3.3.1 Audio Connector

CN Label:	AUDIO_CV1
CN Type:	Audio jack
CN Location:	See Figure 3-21

The audio jacks connect to external audio devices.

- Line Out port (Lime): Connects to a headphone or a speaker. With multi-channel configurations, this port can also connect to front speakers.
- Microphone (Pink): Connects to a microphone.



Figure 3-22: Audio Connector

3.3.2 Ethernet and USB Connector

CN Label:	LANUSB1, LANUSB2
CN Type:	RJ-45 , USB port

CN Location: See Figure 3-21

CN Pinouts: See Figure 3-23 and Table 3-20

The LAN connector connects to a local network.

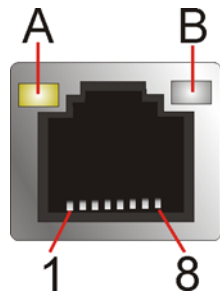

Figure 3-23: LAN Connector

The USB connector can be connected to a USB device.

PIN NO.	DESCRIPTION	PIN NO.	DESCRIPTION
P1	+V3.3A_LAN1	P2	LAN1_MDIPO
P3	LAN1_MDINO	P4	LAN1_MDIP1
P5	LAN1_MDIN1	P6	LAN1_MDIP2
P7	LAN1_MDN2	P8	LAN1_MDIP3
P9	LAN1_MDIN3	P10	GND
P11	LAN1_LINK100	P12	LAN1_LINK1000
P13	LAN1_ACT-1	P14	+V3.3A_LAN1
U1	+USB_PWR1	U2	USB20_C_N0
U3	USB20_C_P0	U4	GND
U5	+USB_PWR1	U6	USB20_C_N1
U7	USB20_C_P1	U8	GND

Table 3-20: LAN and USB Connector Pinouts

3.3.3 Keyboard and PS/2 Mouse Connector

CN Label: KB_MS2

CN Type: Dual PS/2 port

CN Location: See Figure 3-21

KINO-AH612

CN Pinouts: See **Table 3-21**

The PS/2 ports are for connecting a PS/2 mouse and a PS/2 keyboard.

Pin	Description
1	VCC5_KBMS
2	MSDATA
3	MSCLK
4	KBDATA
5	KBCLK
6	KBGND

Table 3-21: Keyboard PS/2 Connector Pinouts

3.3.4 Serial Port Connector

CN Label: COM1, COM2

CN Type: Dual DB-9 port

CN Location: See **Figure 3-21**

CN Pinouts: See **Table 3-22**

The serial port connects to a RS-232 serial communications device.

Pin	Description	Pin	Description
1	DCD	6	DSR
2	RXD	7	RTS
3	TXD	8	CTS
4	DTR	9	RI
5	GND		

Table 3-22: Serial Port Pinouts

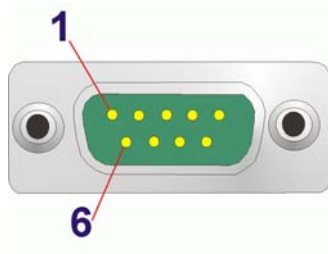

Figure 3-24: Serial Port Pinouts

3.3.5 DVI-D + VGA Connector

- CN Label:** CRT1, CRT2
- CN Type:** 15-pin female (VGA)
- CN Location:** See Figure 3-21
- CN Pinouts:** See Figure 3-25 and Table 3-23

The VGA port connects to a monitor that accepts a standard VGA input.

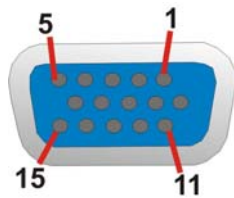

Figure 3-25: VGA Connector

PIN	DESCRIPTION	PIN	DESCRIPTION
1	RED	9	CRT_VCC
2	GREEN	10	GROUND
3	BLUE	11	NC
4	NC	12	5VDDCDA
5	GROUND	13	5HSYNC
6	CRT_PLUG#	14	5VSYNC
7	GROUND	15	5DDCCLK
8	GROUND		

Table 3-23: VGA Connector Pinouts

KINO-AH612

The 24-pin Digital Visual Interface (DVI) connector connects to high-speed, high-resolution digital displays. The DVI-I connector supports both digital and analog signals.

Pin	Description	Pin	Description	Pin	Description
1	TMDS Data2-	9	TMDS Data1-	17	TMDS Data0-
2	TMDS Data2+	10	TMDS Data1+	18	TMDS Data0+
3	GND	11	GND	19	GND
4	N/C	12	NC	20	NC
5	N/C	13	NC	21	NC
6	DDC Clock [SCL]	14	PVDD1	22	GND
7	DDC Data [SDA]	15	GND	23	TMDS Clock +
8	Analog vertical sync	16	GND	24	TMDS Clock -
C1	Analog Red	--	--	--	--
C2	Analog Green	--	--	--	--
C3	Analog Blue	--	--	--	--
C4	Analog Horizontal Sync	--	--	--	--
C5	Analog GND	--	--	--	--

Table 3-24: DVI Connector Pinouts



Chapter

4

Installation

4.1 Anti-static Precautions



WARNING:

Failure to take ESD precautions during the installation of the KINO-AH612 may result in permanent damage to the KINO-AH612 and severe injury to the user.

Electrostatic discharge (ESD) can cause serious damage to electronic components, including the KINO-AH612. Dry climates are especially susceptible to ESD. It is therefore critical that whenever the KINO-AH612 or any other electrical component is handled, the following anti-static precautions are strictly adhered to.

- ***Wear an anti-static wristband:*** Wearing a simple anti-static wristband can help to prevent ESD from damaging the board.
- ***Self-grounding:*** Before handling the board, touch any grounded conducting material. During the time the board is handled, frequently touch any conducting materials that are connected to the ground.
- ***Use an anti-static pad:*** When configuring the KINO-AH612, place it on an anti-static pad. This reduces the possibility of ESD damaging the KINO-AH612.
- ***Only handle the edges of the PCB:*** When handling the PCB, hold the PCB by the edges.

4.2 Installation Considerations



NOTE:

The following installation notices and installation considerations should be read and understood before the KINO-AH612 is installed. All installation notices pertaining to the installation of the KINO-AH612 should be strictly adhered to. Failing to adhere to these precautions may lead to severe damage of the KINO-AH612 and injury to the person installing the motherboard.



WARNING:

The installation instructions described in this manual should be carefully followed in order to prevent damage to the KINO-AH612, KINO-AH612 components and injury to the user.

Before and during the installation please **DO** the following:

- Read the user manual:
 - The user manual provides a complete description of the KINO-AH612 installation instructions and configuration options.
- Wear an electrostatic discharge cuff (ESD):
 - Electronic components are easily damaged by ESD. Wearing an ESD cuff removes ESD from the body and helps prevent ESD damage.
- Place the KINO-AH612 on an antistatic pad:
 - When installing or configuring the motherboard, place it on an antistatic pad. This helps to prevent potential ESD damage.
- Turn all power to the KINO-AH612 off:
 - When working with the KINO-AH612, make sure that it is disconnected from all power supplies and that no electricity is being fed into the system.

KINO-AH612

Before and during the installation of the KINO-AH612 **DO NOT:**

- Remove any of the stickers on the PCB board. These stickers are required for warranty validation.
- Use the product before verifying all the cables and power connectors are properly connected.
- Allow screws to come in contact with the PCB circuit, connector pins, or its components.

4.3 Basic Installation



WARNING:

A CPU should never be turned on without the specified cooling kit being installed. If the cooling kit (heat sink and fan) is not properly installed and the system turned on, permanent damage to the CPU, KINO-AH612 and other electronic components attached to the system may be incurred. Running a CPU without a cooling kit may also result in injury to the user.

The CPU, CPU cooling kit and DIMM are the most critical components of the KINO-AH612. If one of these component is not installed the KINO-AH612 cannot run.

4.3.1 Socket LGA1155 CPU Installation



WARNING:

CPUs are expensive and sensitive components. When installing the CPU please be careful not to damage it in anyway. Make sure the CPU is installed properly and ensure the correct cooling kit is properly installed.

Do NOT touch the pins at the bottom of the CPU. When handling the CPU, only hold it on the sides.

To install the CPU, follow the steps below.

Step 1: Disengage the load lever by pressing the lever down and slightly outwards to clear the retention tab. Fully open the lever. See **Figure 4-1**.

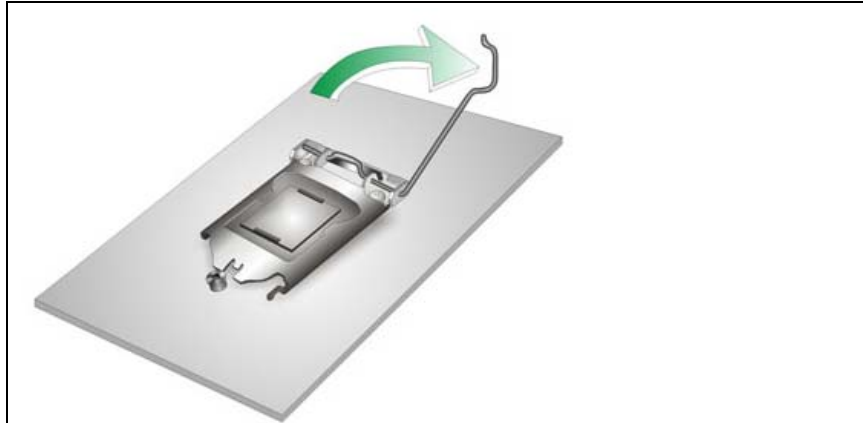

Figure 4-1: Disengage the CPU Socket Load Lever

Step 2: Open the socket and remove the protective cover. The black protective cover can be removed by pulling up on the tab labeled “Remove”. See **Figure 4-2**.

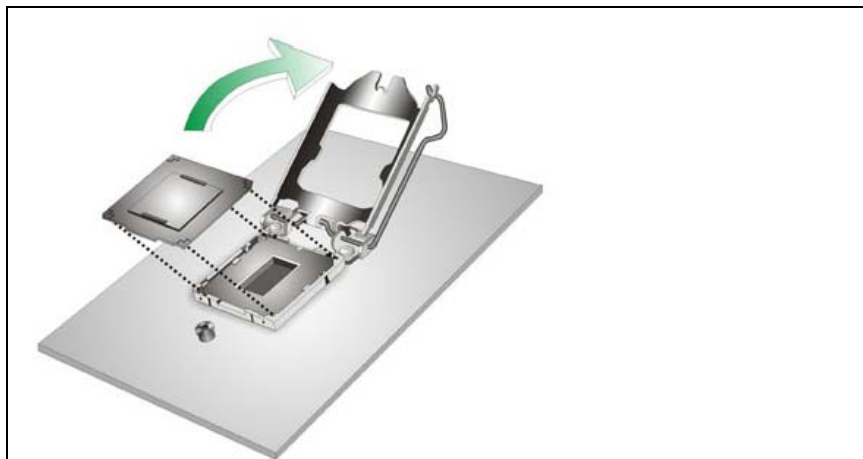

Figure 4-2: Remove Protective Cover

Step 3: Inspect the CPU socket. Make sure there are no bent pins and make sure the socket contacts are free of foreign material. If any debris is found, remove it with compressed air.

KINO-AH612

- Step 4: Orientate the CPU properly.** The contact array should be facing the CPU socket.
- Step 5: Correctly position the CPU.** Match the Pin 1 mark with the CPU edge on the CPU socket.
- Step 6: Align the CPU pins.** Locate pin 1 and the two orientation notches on the CPU. Carefully match the two orientation notches on the CPU with the socket alignment keys.
- Step 7: Insert the CPU.** Gently insert the CPU into the socket. If the CPU pins are properly aligned, the CPU should slide into the CPU socket smoothly. See **Figure 4-3**.

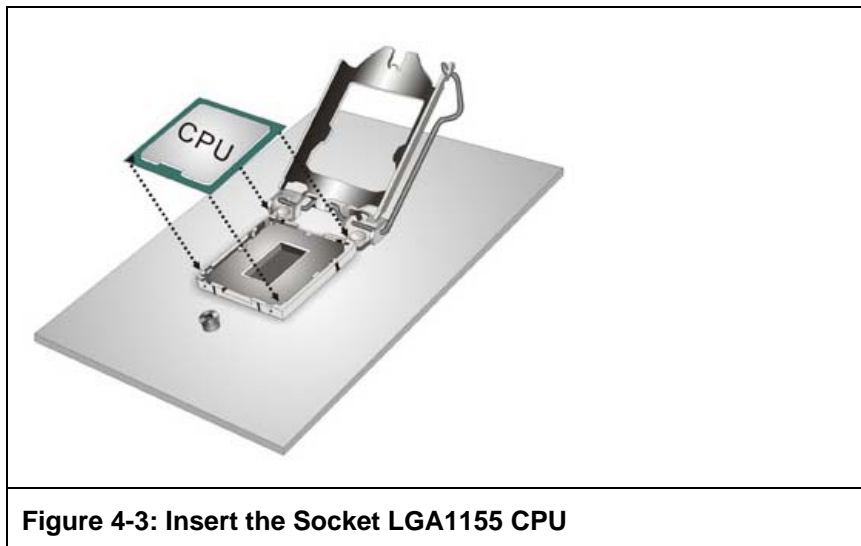

Figure 4-3: Insert the Socket LGA1155 CPU

- Step 8: Close the CPU socket.** Close the load plate and pull the load back a little to have the load plate be able to secure to the knob. Engage the load lever by pushing it back to its original position. See **Figure 4-4**. There will be some resistance, but will not require extreme pressure.

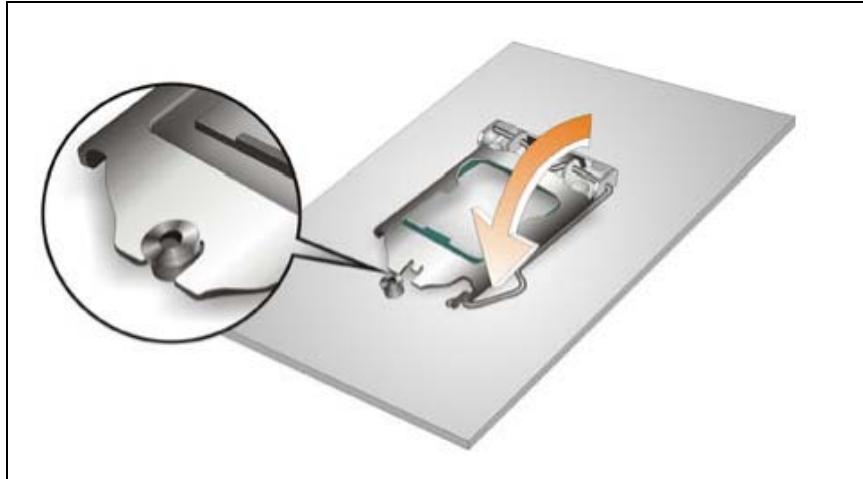

Figure 4-4: Close the Socket LGA1155

Step 9: Connect the 12 V power to the board. Connect the 12 V power from the power supply to the board.

4.3.2 Cooling Kit Installation



WARNING:

DO NOT attempt to install a push-pin cooling fan.

The pre-installed support bracket prevents the board from bending and is ONLY compatible with captive screw type cooling fans.



Figure 4-5: Cooling Kits (CF-1156A-RS, CF-1156B-RS, CF-1156C-RS, CF-1156D-RS)

The cooling kits can be bought from IEI. The cooling kit has a heat sink and fan.

**WARNING:**

Do not wipe off (accidentally or otherwise) the pre-sprayed layer of thermal paste on the bottom of the heat sink. The thermal paste between the CPU and the heat sink is important for optimum heat dissipation.

To install the cooling kit, follow the instructions below.

Step 1: A cooling kit bracket is pre-installed on the rear of the motherboard. See **Figure 4-6**.

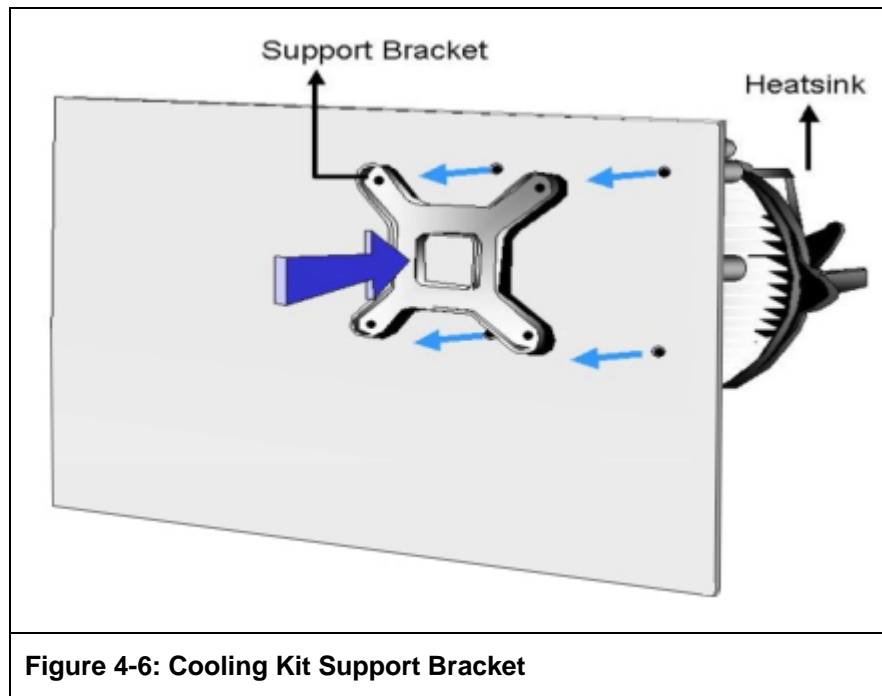

Figure 4-6: Cooling Kit Support Bracket

Step 2: Place the cooling kit onto the socket LGA1155 CPU. Make sure the CPU cable can be properly routed when the cooling kit is installed.

Step 3: Mount the cooling kit. Gently place the cooling kit on top of the CPU. Make sure the four threaded screws on the corners of the cooling kit properly pass through the holes of the cooling kit bracket.

Step 4: Secure the cooling kit by fastening the four retention screw of the cooling kit.

Step 5: Connect the fan cable. Connect the cooling kit fan cable to the fan connector on the KINO-AH612. Carefully route the cable and avoid heat generating chips and fan blades.

4.3.3 DIMM Installation

To install a DIMM, please follow the steps below and refer to **Figure 4-7**.

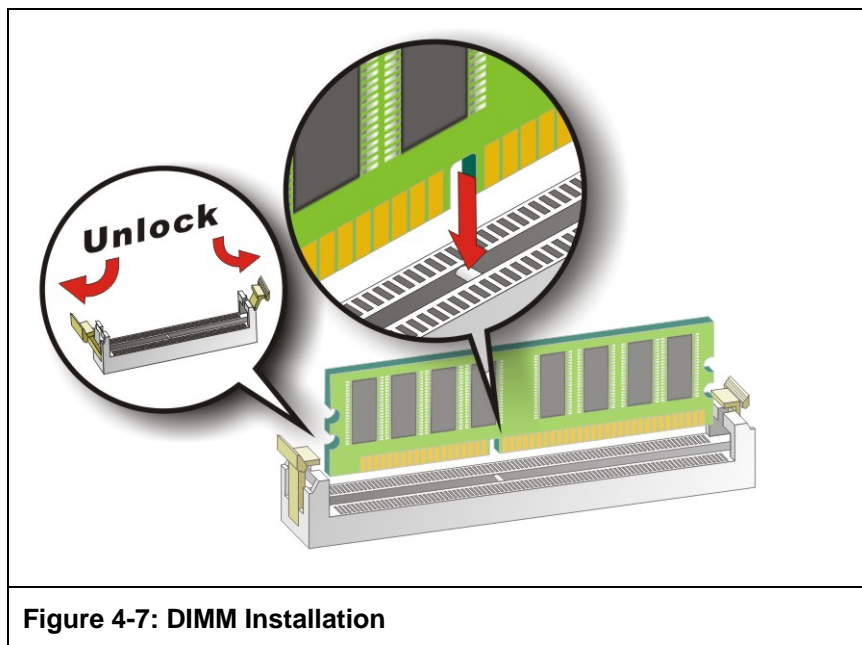

Figure 4-7: DIMM Installation

Step 1: Open the DIMM socket handles. Open the two handles outwards as far as they can. See **Figure 4-7**.

Step 2: Align the DIMM with the socket. Align the DIMM so the notch on the memory lines up with the notch on the memory socket. See **Figure 4-7**.

Step 3: Insert the DIMM. Once aligned, press down until the DIMM is properly seated. Clip the two handles into place. See **Figure 4-7**.

Step 4: Remove a DIMM. To remove a DIMM, push both handles outwards. The memory module is ejected by a mechanism in the socket.

4.4 Jumper Settings



NOTE:

A jumper is a metal bridge used to close an electrical circuit. It consists of two or three metal pins and a small metal clip (often protected by a plastic cover) that slides over the pins to connect them. To CLOSE/SHORT a jumper means connecting the pins of the jumper with the plastic clip and to OPEN a jumper means removing the plastic clip from a jumper.

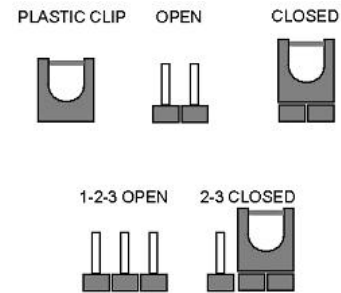

Figure 4-8: Jumper Locations

Before the KINO-AH612 is installed in the system, the jumpers must be set in accordance with the desired configuration. The jumpers on the KINO-AH612 are listed in **Table 4-1**.

Description	Type	Label
AT/ATX mode select	3-pin header	JATX_AT1
Clear CMOS	3-pin header	J_CMOS1

Table 4-1: Jumpers

4.4.1 AT/ATX Mode Select Jumper

- Jumper Label:** JATX_AT1
- Jumper Type:** 3-pin header
- Jumper Settings:** See **Table 4-2**
- Jumper Location:** See **Figure 4-9**

The AT/ATX mode select jumper specifies the systems power mode as AT or ATX. AT/ATX mode select jumper settings are shown in **Table 4-2**.

Setting	Description	
Short 1-2	ATX Mode	Default
Short 2-3	AT Mode	

Table 4-2: AT/ATX Mode Select Jumper Settings

The location of the AT/ATX mode select jumper is shown in **Figure 4-9** below.

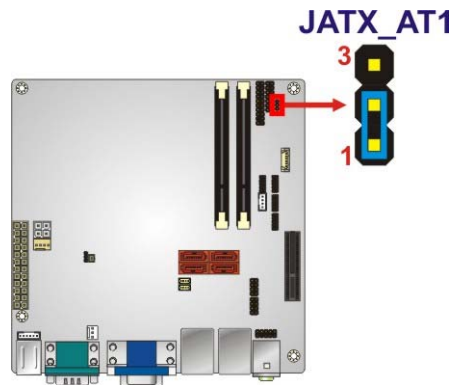

Figure 4-9: AT/ATX Mode Select Jumper Location

4.4.2 Clear CMOS Jumper

Jumper Label:	J_CMOS1
Jumper Type:	3-pin header
Jumper Settings:	See Table 4-3
Jumper Location:	See Figure 4-10

If the KINO-AH612 fails to boot due to improper BIOS settings, the clear CMOS jumper clears the CMOS data and resets the system BIOS information. To do this, use the jumper cap to close pins 2 and 3 for a few seconds then reinstall the jumper clip back to pins 1 and 2.

If the “CMOS Settings Wrong” message is displayed during the boot up process, the fault may be corrected by pressing the F1 to enter the CMOS Setup menu. Do one of the following:

- Enter the correct CMOS setting
- Load Optimal Defaults

KINO-AH612

- Load Failsafe Defaults.

After having done one of the above, save the changes and exit the CMOS Setup menu.

The clear CMOS jumper settings are shown in **Table 4-3**.

Setting	Description	
Short 1-2	Normal Operation	Default
Short 2-3	Clear CMOS Setup	

Table 4-3: Clear CMOS Jumper Settings

The location of the clear CMOS jumper is shown in **Figure 4-10**.

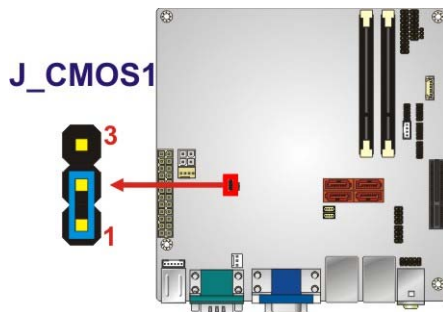

Figure 4-10: Clear CMOS Jumper Location

4.5 Internal Peripheral Device Connections

This section outlines the installation of peripheral devices to the on-board connectors

4.5.1 SATA Drive Connection

The KINO-AH612 is shipped with two SATA drive cables. To connect the SATA drives to the connectors, please follow the steps below.

Step 1: Locate the connectors. The locations of the SATA drive connectors are shown in **Chapter 3**.

Step 2: Insert the cable connector. Insert the cable connector into the on-board SATA drive connector until it clips into place. See Figure 4-11.

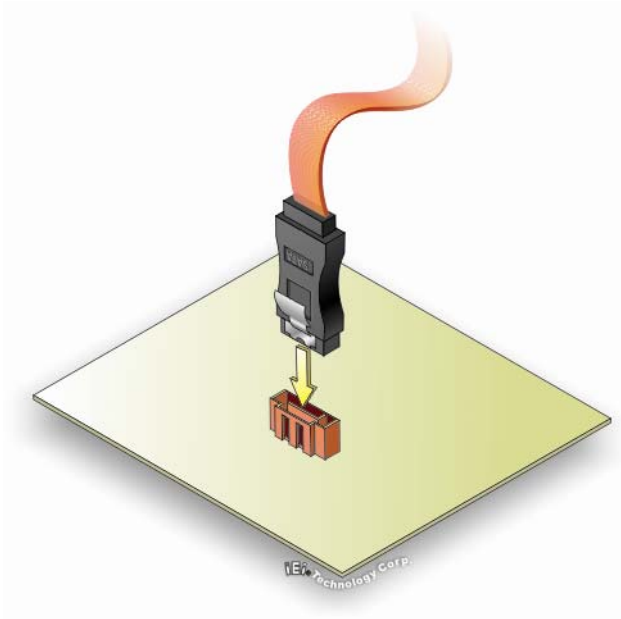

Figure 4-11: SATA Drive Cable Connection

- Step 3:** Connect the cable to the SATA disk. Connect the connector on the other end of the cable to the connector at the back of the SATA drive. See Figure 4-12.
- Step 4:** Connect the SATA power cable. Connect the SATA power connector to the back of the SATA drive. See Figure 4-12.

KINO-AH612

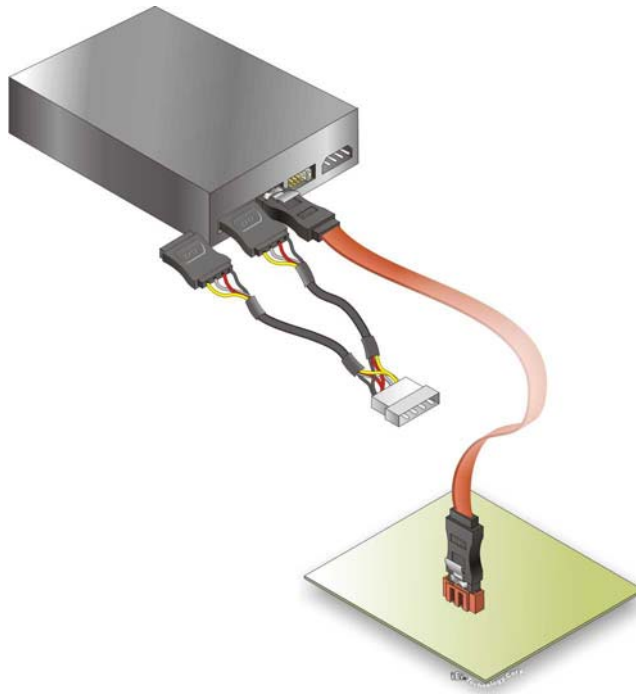

Figure 4-12: SATA Power Drive Connection

4.6 External Peripheral Interface Connection

The following external peripheral devices can be connected to the external peripheral interface connectors.

- Audio devices
- DVI-D devices
- RJ-45 Ethernet cable connector
- USB devices
- VGA monitor

To install these devices, connect the corresponding cable connector from the actual device to the corresponding KINO-AH612 external peripheral interface connector making sure the pins are properly aligned.

4.6.1 Audio Connection

The audio jacks on the external audio connector enable the KINO-AH612 to be connected to a stereo sound setup. To install the audio devices, follow the steps below.

Step 1: Identify the audio plugs. The plugs on your home theater system or speakers may not match the colors on the rear panel. If audio plugs are plugged into the wrong jacks, sound quality will be very bad.

Step 2: Plug the audio plugs into the audio jacks. Plug the audio plugs into the audio jacks. If the plugs on your speakers are different, an adapter will need to be used to plug them into the audio jacks.

- **Line Out port (Lime):** Connects to a headphone or a speaker.
- **Microphone (Pink):** Connects to a microphone.

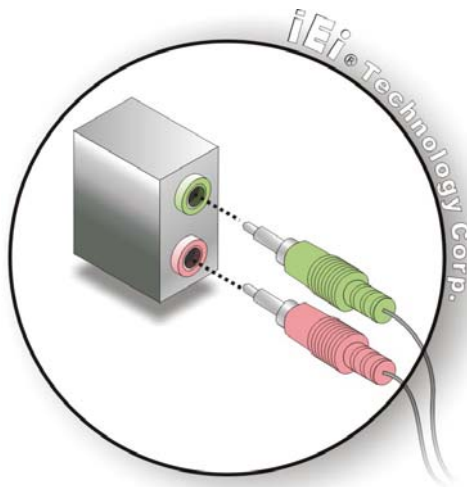

Figure 4-13: Audio Connector

Step 3: Check audio clarity. Check that the sound is coming through the right speakers by adjusting the balance front to rear and left to right.

4.6.2 DVI Connection

The KINO-AH612 has a single female DVI-I connector on the external peripheral interface panel. The DVI-I connector is connected to a digital display device. To connect a digital display device to the KINO-AH612, please follow the instructions below.

Step 1: Locate the DVI-I connector. The location of the DVI-I connector is shown in another chapter.

KINO-AH612

Step 2: Align the DVI-I connector. Align the male DVI-I connector on the digital display device cable with the female DVI-I connector on the external peripheral interface.

Step 3: Insert the DVI-I connector Once the connectors are properly aligned with the male connector, insert the male connector from the digital display device into the female connector on the KINO-AH612. See Figure 4-14.

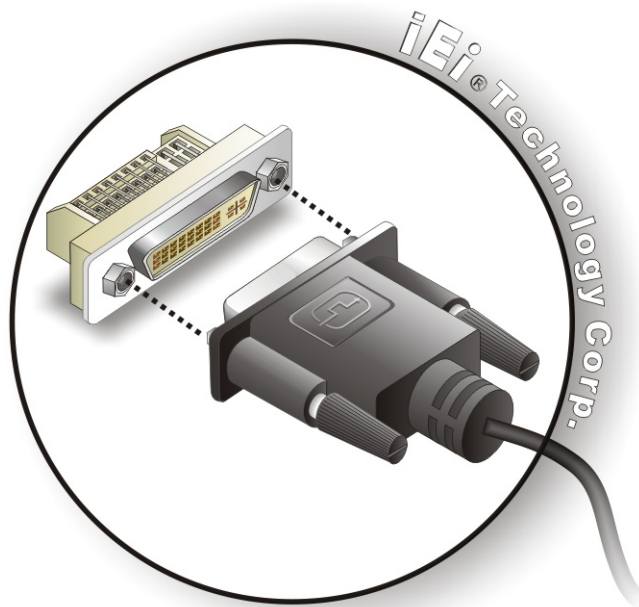

Figure 4-14: DVI Connector

Step 4: Secure the connector. Secure the DVI-I connector from the digital display device to the external interface by tightening the two retention screws on either side of the connector.

4.6.3 LAN Connection

There are two external RJ-45 LAN connectors. The RJ-45 connector enables connection to an external network. To connect a LAN cable with an RJ-45 connector, please follow the instructions below.

Step 1: Locate the RJ-45 connectors. The location of the LAN connectors is shown in

Chapter 3.

Step 2: **Align the connectors.** Align the RJ-45 connector on the LAN cable with one of the RJ-45 connectors on the KINO-AH612. See **Figure 4-15**.

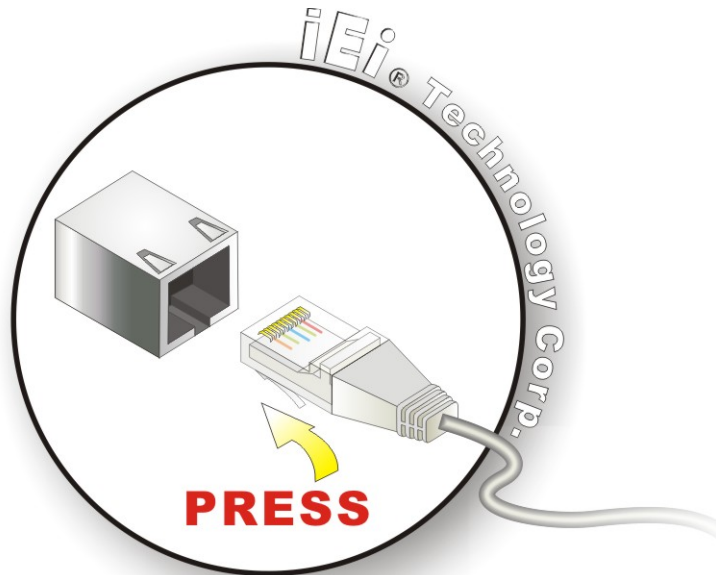

Figure 4-15: LAN Connection

Step 3: **Insert the LAN cable RJ-45 connector.** Once aligned, gently insert the LAN cable RJ-45 connector into the on-board RJ-45 connector.

4.6.4 USB Connection

The external USB Series "A" receptacle connectors provide easier and quicker access to external USB devices. Follow the steps below to connect USB devices to the KINO-AH612.

Step 1: **Locate the USB Series "A" receptacle connectors.** The location of the USB Series "A" receptacle connectors are shown in **Chapter 3**.

Step 2: **Insert a USB Series "A" plug.** Insert the USB Series "A" plug of a device into the USB Series "A" receptacle on the external peripheral interface. See **Figure 4-16**.

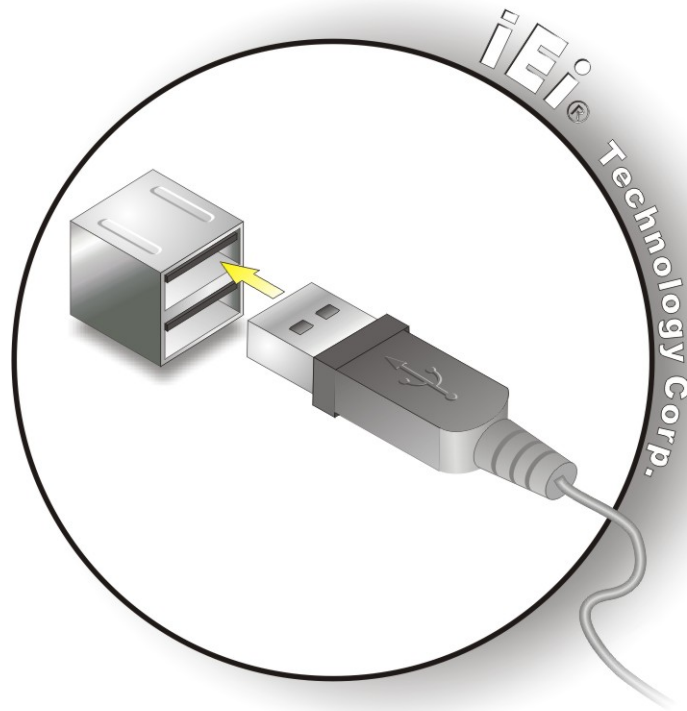

Figure 4-16: USB Connector

4.6.5 VGA Monitor Connection

The KINO-AH612 has a single female DB-15 connector on the external peripheral interface panel. The DB-15 connector is connected to a CRT or VGA monitor. To connect a monitor to the KINO-AH612, please follow the instructions below.

- Step 1: Locate the female DB-15 connector.** The location of the female DB-15 connector is shown in **Chapter 3**.
- Step 2: Align the VGA connector.** Align the male DB-15 connector on the VGA screen cable with the female DB-15 connector on the external peripheral interface.
- Step 3: Insert the VGA connector.** Once the connectors are properly aligned with the insert the male connector from the VGA screen into the female connector on the KINO-AH612. See **Figure 4-17**.

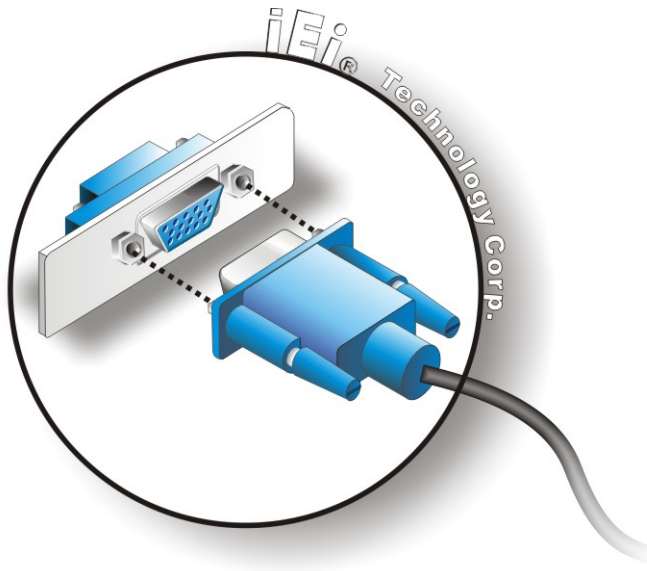

Figure 4-17: VGA Connector

Step 4: Secure the connector. Secure the DB-15 VGA connector from the VGA monitor to the external interface by tightening the two retention screws on either side of the connector.

Chapter

5

BIOS Screens

5.1 Introduction

The BIOS is programmed onto the BIOS chip. The BIOS setup program allows changes to certain system settings. This chapter outlines the options that can be changed.

5.1.1 Starting Setup

The AMI BIOS is activated when the computer is turned on. The setup program can be activated in one of two ways.

1. Press the **DELETE** or **F2** key as soon as the system is turned on or
2. Press the **DELETE** or **F2** key when the “**Press Del to enter SETUP**” message appears on the screen.

If the message disappears before the **DELETE** or **F2** key is pressed, restart the computer and try again.

5.1.2 Using Setup

Use the arrow keys to highlight items, press **ENTER** to select, use the PageUp and PageDown keys to change entries, press **F1** for help and press **ESC** to quit. Navigation keys are shown in.

Key	Function
Up arrow	Move to the item above
Down arrow	Move to the item below
Left arrow	Move to the item on the left hand side
Right arrow	Move to the item on the right hand side
+	Increase the numeric value or make changes
-	Decrease the numeric value or make changes
Page up	Move to the next page
Page down	Move to the previous page

Key	Function
Esc	Main Menu – Quit and not save changes into CMOS Status Page Setup Menu and Option Page Setup Menu -- Exit current page and return to Main Menu
F1	General help, only for Status Page Setup Menu and Option Page Setup Menu
F2	Load previous values
F3	Load optimized defaults
F4	Save changes and Exit BIOS

Table 5-1: BIOS Navigation Keys

5.1.3 Getting Help

When **F1** is pressed a small help window describing the appropriate keys to use and the possible selections for the highlighted item appears. To exit the Help Window press **Esc** or the **F1** key again.

5.1.4 Unable to Reboot after Configuration Changes

If the computer cannot boot after changes to the system configuration is made, CMOS defaults. Use the jumper described in **Chapter 4**.

5.1.5 BIOS Menu Bar

The **menu bar** on top of the BIOS screen has the following main items:

- Main – Changes the basic system configuration.
- Advanced – Changes the advanced system settings.
- Chipset – Changes the chipset settings.
- Boot – Changes the system boot configuration.
- Security – Sets User and Supervisor Passwords.
- Save & Exit – Selects exit options and loads default settings

The following sections completely describe the configuration options found in the menu items at the top of the BIOS screen and listed above.

5.2 Main

The **Main** BIOS menu (**BIOS Menu 1**) appears when the **BIOS Setup** program is entered. The **Main** menu gives an overview of the basic system information.

```

Aptio Setup Utility - Copyright (C) 2011 American Megatrends, Inc.
Main  Advanced  Chipset  Boot  Security  Save & Exit

BIOS Information
BIOS Vendor                American Megatrends
Core Version                4.6.4.0 0.03
Compliancy                 UEFI 2.0
Project Version            B224AR10.ROM
Build Date and Time       01/05/2011 12:01:16

Memory Information
Total Memory               2048 MB (DDR3 1333)

System Date                [Tue 01/10/2011]
System Time                [01:33:27]

Access Level               Administrator

Set the Date. Use Tab to
switch between Data
elements.

-----
<->: Select Screen
^ v: Select Item
Enter/Select
+/-: Change Opt.
F1: General Help
F2: Previous Values
F3: Optimized Defaults
F4: Save & Exit
ESC: Exit

Version 2.11.1210. Copyright (C) 2011 American Megatrends, Inc.
  
```

BIOS Menu 1: Main

→ BIOS Information

The **BIOS Information** lists a brief summary of the BIOS. The fields in **BIOS Information** cannot be changed. The items shown in the system overview include:

- **BIOS Vendor:** Installed BIOS vendor
- **Core Version:** Current BIOS version
- **Compliancy:** Current compliant version
- **Project Version:** the board version
- **Build Date and Time:** Date the current BIOS version was made

→ Memory Information

The **Memory Information** lists a brief summary of the on-board memory. The fields in **Memory Information** cannot be changed.

- **Total Memory:** Displays the auto-detected system memory size and type.

KINO-AH612

The System Overview field also has two user configurable fields:

→ **System Date [xx/xx/xx]**

Use the **System Date** option to set the system date. Manually enter the day, month and year.

→ **System Time [xx:xx:xx]**

Use the **System Time** option to set the system time. Manually enter the hours, minutes and seconds.

5.3 Advanced

Use the **Advanced** menu (**BIOS Menu 2**) to configure the CPU and peripheral devices through the following sub-menus:



WARNING!

Setting the wrong values in the sections below may cause the system to malfunction. Make sure that the settings made are compatible with the hardware.

```

Aptio Setup Utility - Copyright (C) 2011 American Megatrends, Inc.
Main  Advanced  Chipset  Boot  Security  Save & Exit

> ACPI Settings
> Trusted Computing
> CPU Configuration
> SATA Configuration
> Intel TXT(LT) Configuration
> USB Configuration
> Super IO Configuration
> H/M Monitor
> Serial Port Console Redirection
> iEi Feature

System ACPI Parameters

-----
<=>: Select Screen
↑↓: Select Item
Enter>Select
+/-: Change Opt.
F1: General Help
F2: Previous Values
F3: Optimized Defaults
F4: Save and Exit
ESC: Exit

Version 2.11.1210. Copyright (C) 2011 American Megatrends, Inc.

```

BIOS Menu 2: Advanced
5.3.1 ACPI Configuration

The **ACPI Configuration** menu (**BIOS Menu 3**) configures the Advanced Configuration and Power Interface (ACPI) options.

```

Aptio Setup Utility - Copyright (C) 2011 American Megatrends, Inc.
Advanced

ACPI Settings
ACPI Sleep State          [S1 (CPU Stop Clock)]

Select the highest API
sleep state the system
will enter when the
SUSPEND button is
pressed.

-----
<=>: Select Screen
↑↓: Select Item
Enter>Select
+/-: Change Opt.
F1: General Help
F2: Previous Values
F3: Optimized Defaults
F4: Save & Exit
ESC: Exit

Version 2.11.1210. Copyright (C) 2011 American Megatrends, Inc.

```

BIOS Menu 3: ACPI Configuration

KINO-AH612

→ ACPI Sleep State [S1 (CPU Stop Clock)]

Use the **ACPI Sleep State** option to specify the sleep state the system enters when it is not being used.

→ Suspend Disabled

→ **S1 (CPU Stop Clock)** **DEFAULT** The system enters S1 (POS) sleep state. The system appears off. The CPU is stopped; RAM is refreshed; the system is running in a low power mode.

→ **S3 (Suspend to RAM)** The caches are flushed and the CPU is powered off. Power to the RAM is maintained. The computer returns slower to a working state, but more power is saved.

5.3.2 Trusted Computing

Use the **Trusted Computing** menu (**BIOS Menu 4**) to configure settings related to the Trusted Computing Group (TCG) Trusted Platform Module (TPM).

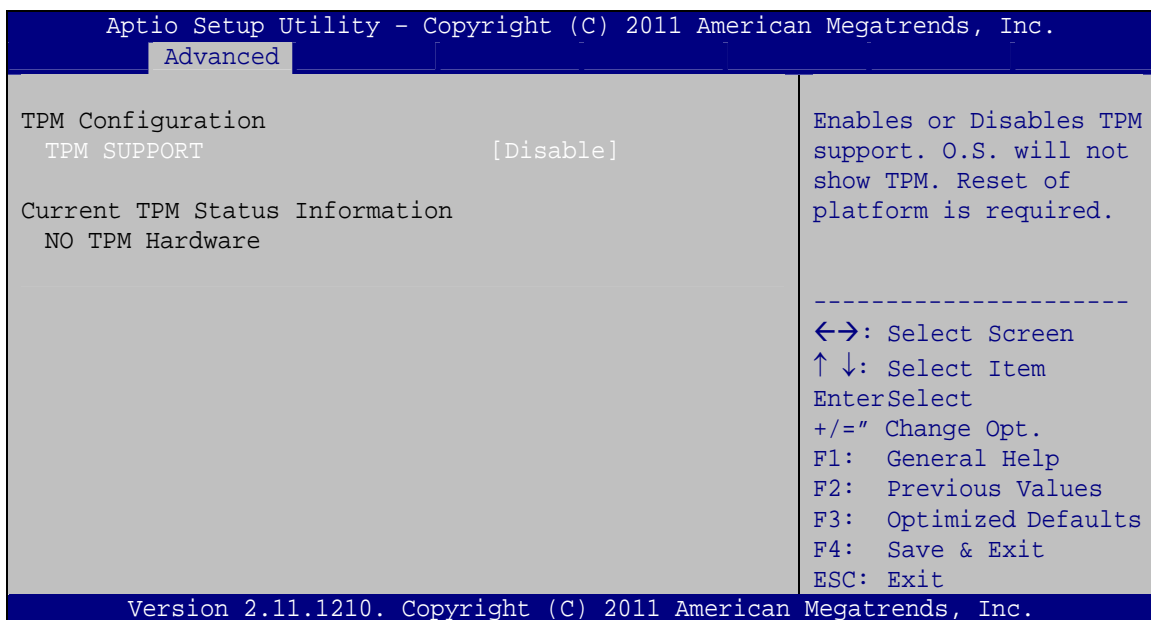

BIOS Menu 4: TPM Configuration

➔ **TPM Support [Disable]**

Use the **TPM Support** option to configure support for the TPM.

➔ **Disable** **DEFAULT** TPM support is disabled.

➔ **Enable** TPM support is enabled.

5.3.3 CPU Configuration

Use the **CPU Configuration** menu (**BIOS Menu 5**) to enter the **CPU Information** submenu or enable Intel Virtualization Technology.

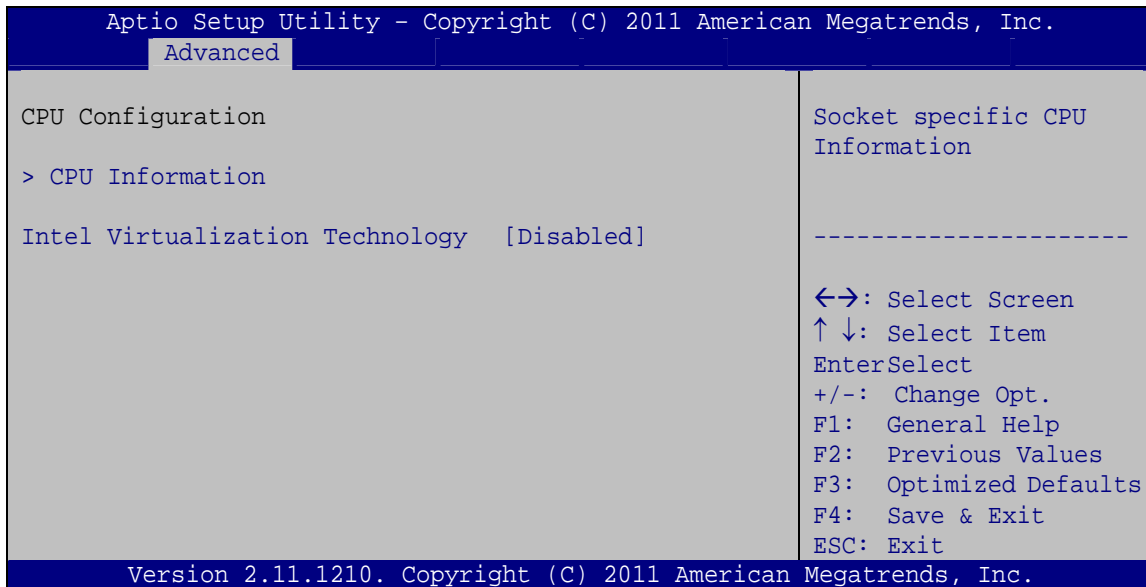

BIOS Menu 5: CPU Configuration

➔ **Intel Virtualization Technology [Disabled]**

Use the **Intel Virtualization Technology** option to enable or disable virtualization on the system. When combined with third party software, Intel Virtualization technology allows several OSs to run on the same system at the same time.

➔ **Disabled** **DEFAULT** Disables Intel Virtualization Technology.

➔ **Enabled** Enables Intel Virtualization Technology.

5.3.3.1 CPU Information

Use the **CPU Information** submenu (**BIOS Menu 6**) to view detailed CPU specifications and configure the CPU.

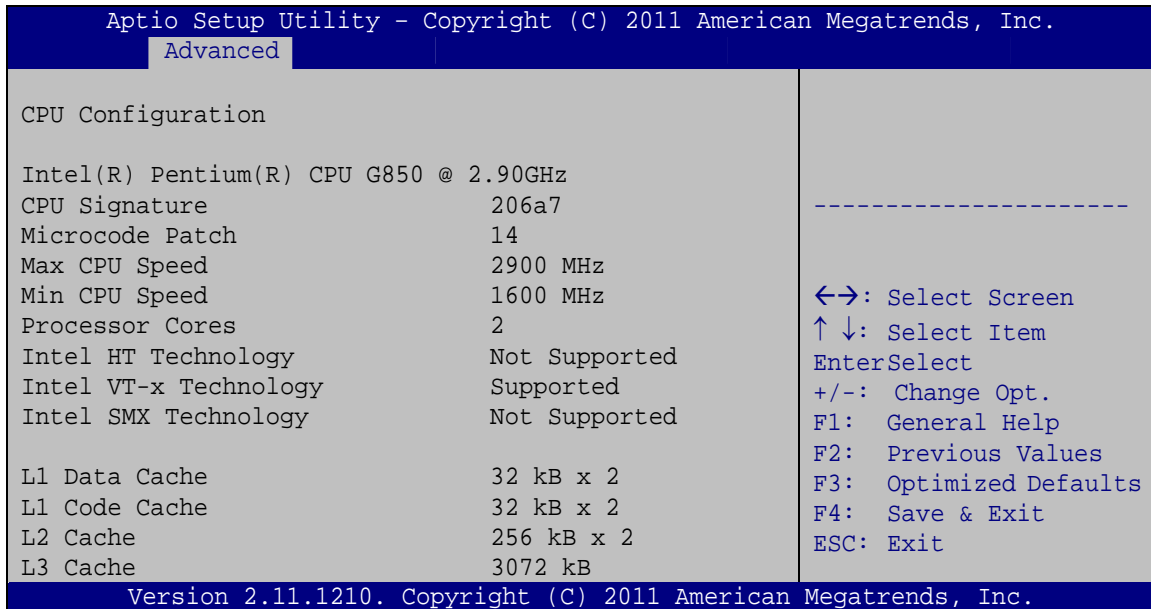

BIOS Menu 6: CPU Configuration

The CPU Configuration menu (**BIOS Menu 6**) lists the following CPU details:

- Processor Type: Lists the brand name of the CPU being used
- CPU Signature: Lists the CPU signature value.
- Microcode Patch: Lists the microcode patch being used.
- Max CPU Speed: Lists the maximum CPU processing speed.
- Min CPU Speed: Lists the minimum CPU processing speed.
- Processor Cores: Lists the number of the processor core
- Intel HT Technology: Indicates if Intel HT Technology is supported by the CPU.
- Intel VT-x Technology: Indicates if Intel VT-x Technology is supported by the CPU.
- Intel SMX Technology: Indicates if Intel SMX Technology is supported by the CPU.
- L1 Data Cache: Lists the amount of data storage space on the L1 cache.
- L1 Code Cache: Lists the amount of code storage space on the L1 cache.

- L2 Cache: Lists the amount of storage space on the L2 cache.
- L3 Cache: Lists the amount of storage space on the L3 cache.

5.3.4 SATA Configuration

Use the **SATA Configuration** menu (**BIOS Menu 7**) to change and/or set the configuration of the SATA devices installed in the system.

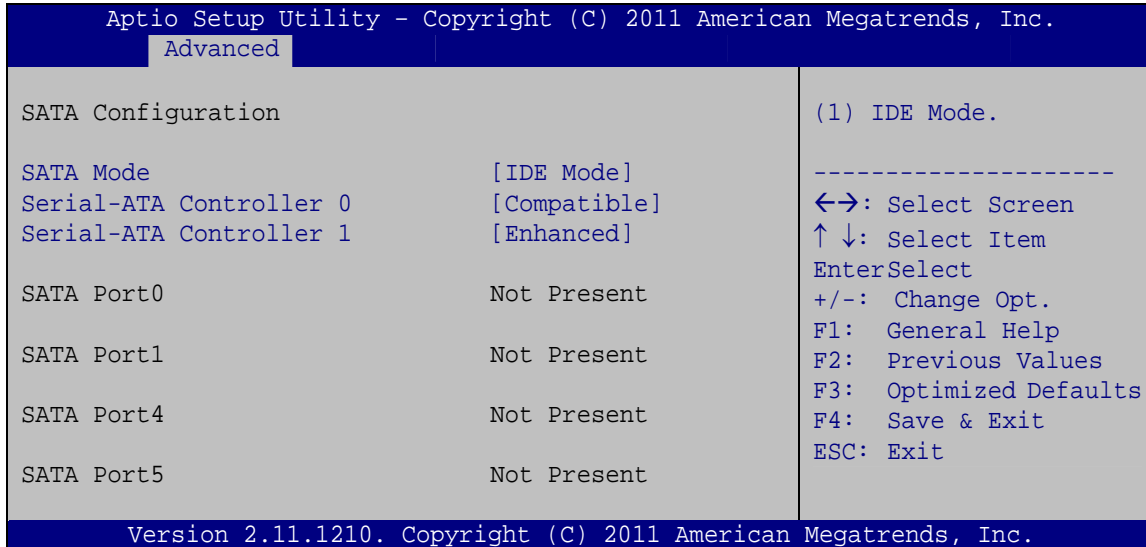

BIOS Menu 7: IDE Configuration

→ SATA Mode [IDE Mode]

Use the **SATA Mode** option to configure SATA devices as normal IDE devices.

- **Disabled** Disables SATA devices.
- **IDE Mode** **DEFAULT** Configures SATA devices as normal IDE device.
- **AHCI Mode** Configures SATA devices as an AHCI device.

→ Serial-ATA Controller 0 [Compatible]

Use the **Serial-ATA Controller 0** option to configure the Serial-ATA controller mode when the SATA mode is set to IDE Mode.

- **Disabled** Disables Serial-ATA controller.

KINO-AH612

- ➔ **Enhanced** Configures the Serial-ATA controller to be in enhanced mode. In this mode, IDE channels and SATA channels are separated. Some legacy OS do not support this mode.
- ➔ **Compatible** **DEFAULT** Configures the Serial-ATA controller to be in compatible mode. In this mode, a SATA channel will replace one of the IDE channels.

➔ **Serial-ATA Controller 1 [Enhanced]**

Use the **Serial-ATA Controller 1** option to configure the Serial-ATA controller mode when the SATA mode is set to IDE Mode.

- ➔ **Disabled** Disables Serial-ATA controller.
- ➔ **Enhanced** **DEFAULT** Configures the Serial-ATA controller to be in enhanced mode. In this mode, IDE channels and SATA channels are separated. Some legacy OS do not support this mode.

5.3.5 Intel TXT(LT) Configuration

Use the **Intel TXT(LT) Configuration** menu (**BIOS Menu 8**) to configure Intel Trusted Execution Technology support.

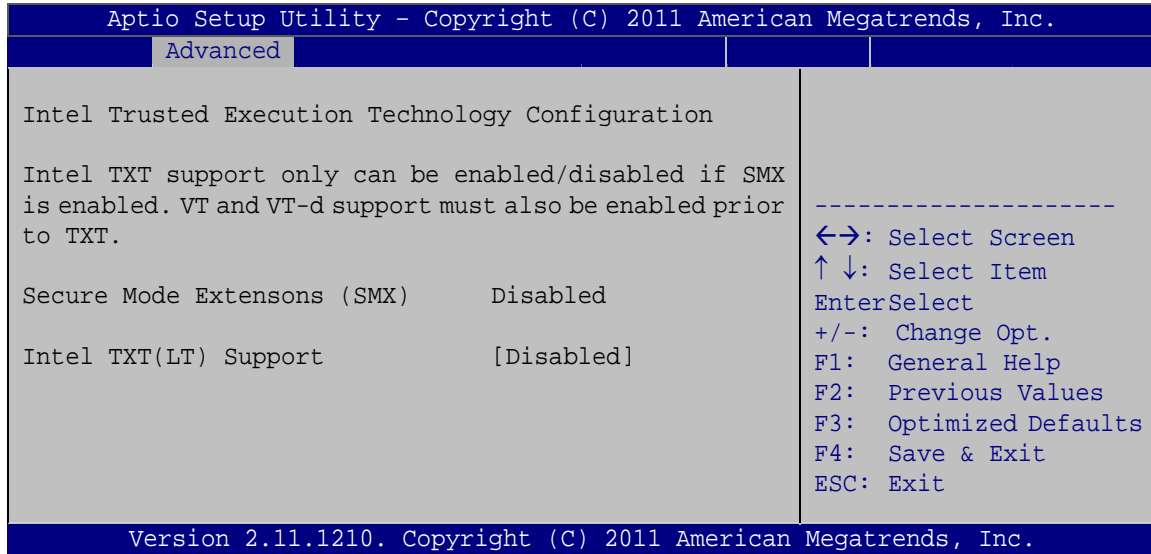

BIOS Menu 8: Intel TXT(LT) Configuration

5.3.6 USB Configuration

Use the **USB Configuration** menu (**BIOS Menu 9**) to read USB configuration information and configure the USB settings.

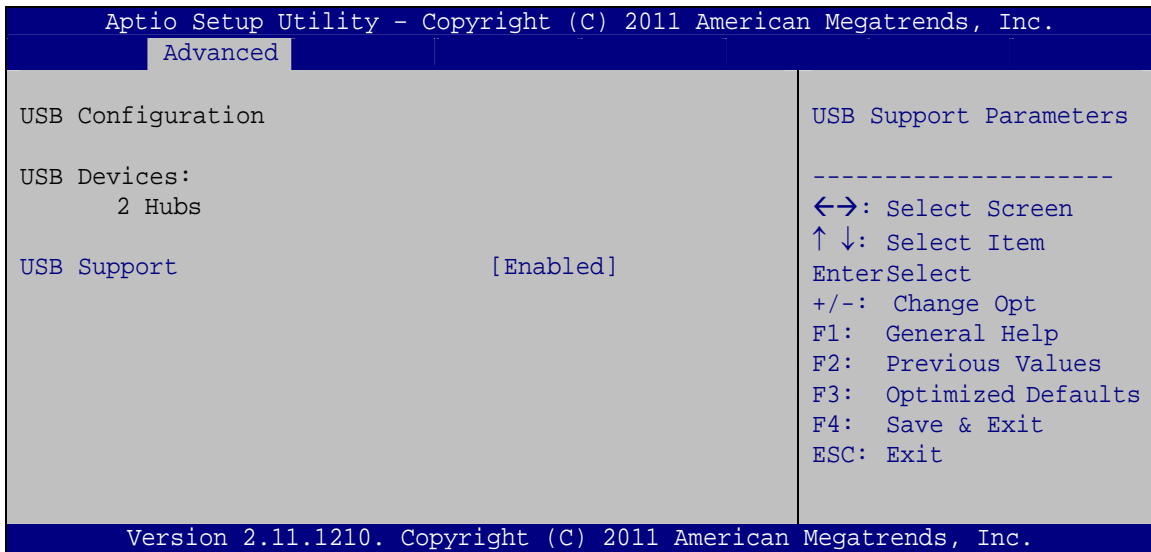

BIOS Menu 9: USB Configuration

➔ **USB Devices**

The **USB Devices Enabled** field lists the USB devices that are enabled on the system

KINO-AH612

→ USB Support [Enabled]

Use the **USB Support** option to enable or disable USB support on the system.

- **Disabled** USB support disabled
- **Enabled** **DEFAULT** USB support enabled

5.3.7 Super IO Configuration

Use the **Super IO Configuration** menu (**BIOS Menu 10**) to set or change the configurations for the FDD controllers, parallel ports and serial ports.

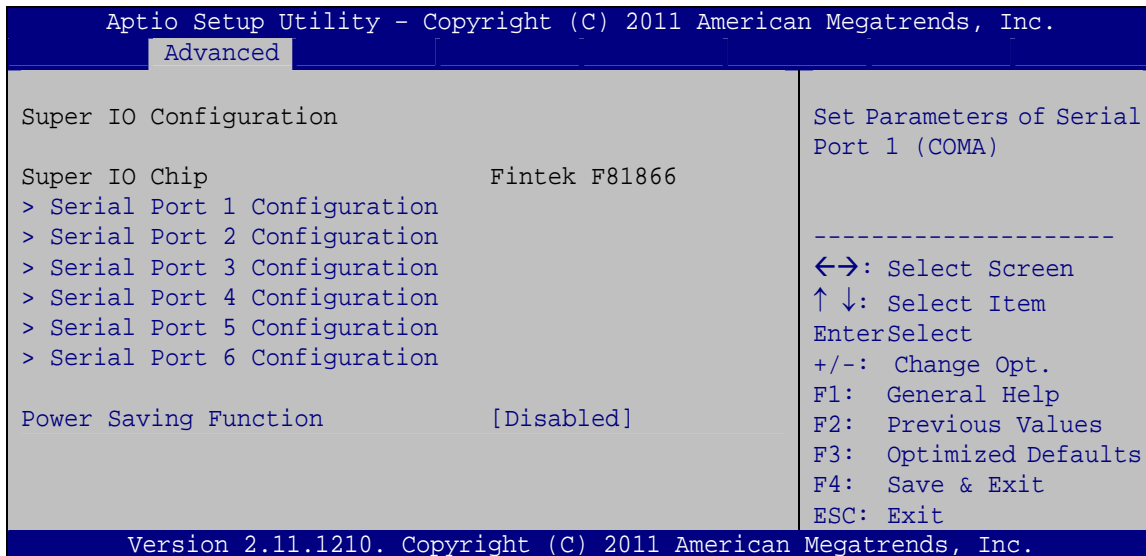

BIOS Menu 10: Super IO Configuration

→ Power Saving Function [Disabled]

Use the **Power Saving Function** option to enable or disable power saving.

- **Disabled** Disables power saving
- **Enabled** **DEFAULT** Enables power saving

5.3.7.1 Serial Port n Configuration

Use the **Serial Port n Configuration** menu (**BIOS Menu 15**) to configure the serial port n.

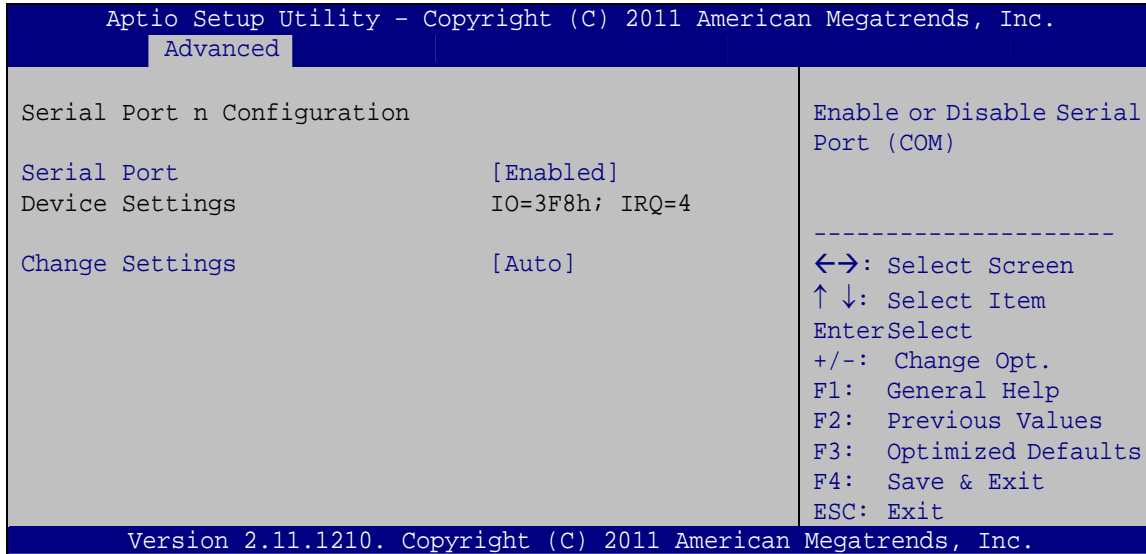

BIOS Menu 11: Serial Port n Configuration Menu

5.3.7.1.1 Serial Port 1 Configuration

→ Serial Port [Enabled]

Use the **Serial Port** option to enable or disable the serial port.

- **Disabled** Disable the serial port
- **Enabled DEFAULT** Enable the serial port

→ Change Settings [Auto]

Use the **Change Settings** option to change the serial port IO port address and interrupt address.

- **Auto DEFAULT** The serial port IO port address and interrupt address are automatically detected.
- **IO=3F8h; Serial Port I/O port address is 3F8h and the interrupt
IRQ=4 address is IRQ4**

KINO-AH612

- ➔ **IO=3F8h;**
IRQ=3, 4 Serial Port I/O port address is 3F8h and the interrupt address is IRQ3,4
- ➔ **IO=2F8h;**
IRQ=3, 4 Serial Port I/O port address is 2F8h and the interrupt address is IRQ3,4
- ➔ **IO=2C0h;**
IRQ=3, 4 Serial Port I/O port address is 2C0h and the interrupt address is IRQ3, 4
- ➔ **IO=2C8h;**
IRQ=3, 4 Serial Port I/O port address is 2C8h and the interrupt address is IRQ3, 4

5.3.7.1.2 Serial Port 2 Configuration

➔ Serial Port [Enabled]

Use the **Serial Port** option to enable or disable the serial port.

- ➔ **Disabled** Disable the serial port
- ➔ **Enabled** **DEFAULT** Enable the serial port

➔ Change Settings [Auto]

Use the **Change Settings** option to change the serial port IO port address and interrupt address.

- ➔ **Auto** **DEFAULT** The serial port IO port address and interrupt address are automatically detected.
- ➔ **IO=2F8h;**
IRQ=3 Serial Port I/O port address is 2F8h and the interrupt address is IRQ3
- ➔ **IO=3F8h;**
IRQ=3, 4 Serial Port I/O port address is 3F8h and the interrupt address is IRQ3, 4
- ➔ **IO=2F8h;**
IRQ=3, 4 Serial Port I/O port address is 2F8h and the interrupt address is IRQ3, 4
- ➔ **IO=2C0h;**
IRQ=3, 4 Serial Port I/O port address is 2C0h and the interrupt address is IRQ3, 4

- **IO=2C8h;**
IRQ=3, 4 Serial Port I/O port address is 2C8h and the interrupt address is IRQ3, 4

5.3.7.1.3 Serial Port 3 Configuration

→ Serial Port [Enabled]

Use the **Serial Port** option to enable or disable the serial port.

- **Disabled** Disable the serial port
- **Enabled** **DEFAULT** Enable the serial port

→ Change Settings [Auto]

Use the **Change Settings** option to change the serial port IO port address and interrupt address.

- **Auto** **DEFAULT** The serial port IO port address and interrupt address are automatically detected.
- **IO=3E8h;**
IRQ=10 Serial Port I/O port address is 3E8h and the interrupt address is IRQ10
- **IO=3E8h;**
IRQ=10, 11 Serial Port I/O port address is 3E8h and the interrupt address is IRQ10, 11
- **IO=2E8h;**
IRQ=10, 11 Serial Port I/O port address is 2E8h and the interrupt address is IRQ10, 11
- **IO=2D0h;**
IRQ=10, 11 Serial Port I/O port address is 2D0h and the interrupt address is IRQ10, 11
- **IO=2D8h;**
IRQ=10, 11 Serial Port I/O port address is 2D8h and the interrupt address is IRQ10, 11

5.3.7.1.4 Serial Port 4 Configuration

→ **Serial Port [Enabled]**

Use the **Serial Port** option to enable or disable the serial port.

- **Disabled** Disable the serial port
- **Enabled DEFAULT** Enable the serial port

→ **Change Settings [Auto]**

Use the **Change Settings** option to change the serial port IO port address and interrupt address.

- **Auto DEFAULT** The serial port IO port address and interrupt address are automatically detected.
- **IO=2E8h;
IRQ=10** Serial Port I/O port address is 2E8h and the interrupt address is IRQ10
- **IO=3E8h;
IRQ=10, 11** Serial Port I/O port address is 3E8h and the interrupt address is IRQ10, 11
- **IO=2E8h;
IRQ=10, 11** Serial Port I/O port address is 2E8h and the interrupt address is IRQ10, 11
- **IO=2D0h;
IRQ=10, 11** Serial Port I/O port address is 2D0h and the interrupt address is IRQ10, 11
- **IO=2D8h;
IRQ=10, 11** Serial Port I/O port address is 2D8h and the interrupt address is IRQ10, 11

→ **Device Mode [RS422/485]**

Use the **Device Mode** option to set the communications protocol.

- **RS422/485 DEFAULT** Sets the port for RS-422/485 communications.

5.3.7.1.5 Serial Port 5 Configuration

→ Serial Port [Enabled]

Use the **Serial Port** option to enable or disable the serial port.

- **Disabled** Disable the serial port
- **Enabled** **DEFAULT** Enable the serial port

→ Change Settings [Auto]

Use the **Change Settings** option to change the serial port IO port address and interrupt address.

- **Auto** **DEFAULT** The serial port IO port address and interrupt address are automatically detected.
- **IO=2C0h;**
IRQ=10 Serial Port I/O port address is 2C0h and the interrupt address is IRQ10
- **IO=2C0h;**
IRQ=10, 11 Serial Port I/O port address is 2C0h and the interrupt address is IRQ10, 11
- **IO=2C8h;**
IRQ=10, 11 Serial Port I/O port address is 2C8h and the interrupt address is IRQ10, 11
- **IO=2D0h;**
IRQ=10, 11 Serial Port I/O port address is 2D0h and the interrupt address is IRQ10, 11
- **IO=2D8h;**
IRQ=10, 11 Serial Port I/O port address is 2D8h and the interrupt address is IRQ10, 11
- **IO=2E0h;**
IRQ=10, 11 Serial Port I/O port address is 2E0h and the interrupt address is IRQ10, 11

5.3.7.1.6 Serial Port 6 Configuration

→ **Serial Port [Enabled]**

Use the **Serial Port** option to enable or disable the serial port.

- **Disabled** Disable the serial port
- **Enabled DEFAULT** Enable the serial port

→ **Change Settings [Auto]**

Use the **Change Settings** option to change the serial port IO port address and interrupt address.

- **Auto DEFAULT** The serial port IO port address and interrupt address are automatically detected.
- **IO=2E0h;
IRQ=10** Serial Port I/O port address is 2E0h and the interrupt address is IRQ10
- **IO=2C0h;
IRQ=10, 11** Serial Port I/O port address is 2C0h and the interrupt address is IRQ10, 11
- **IO=2C8h;
IRQ=10, 11** Serial Port I/O port address is 2C8h and the interrupt address is IRQ10, 11
- **IO=2D0h;
IRQ=10, 11** Serial Port I/O port address is 2D0h and the interrupt address is IRQ10, 11
- **IO=2D8h;
IRQ=10, 11** Serial Port I/O port address is 2D8h and the interrupt address is IRQ10, 11
- **IO=2E0h;
IRQ=10, 11** Serial Port I/O port address is 2E0h and the interrupt address is IRQ10, 11

5.3.8 H/W Monitor

The H/W Monitor menu (**BIOS Menu 12**) shows the operating temperature, fan speeds and system voltages.

```

Aptio Setup Utility - Copyright (C) 2011 American Megatrends, Inc.
-----
Advanced
-----
PC Health Status

CPU Temperature           :+101 C
SYS Temperature          :+37 C
CPU FAN Speed             :2824 RPM
SYS FAN Speed             :N/A
VCC3V                     :+3.408 V
V_core                   :+1.056 V
+1.05V                    :+1.048 V
VDDR                      :+1.616 V
VSB3V                     :+3.408 V
VBAT                      :+3.200 V
5VSB                      :+4.944 V

> FAN 1 Configuration
> FAN 2 Configuration

-----
<=>: Select Screen
↑↓: Select Item
EnterSelect
+/-: Change Opt.
F1:  General Help
F2:  Previous Values
F3:  Optimized Defaults
F4:  Save & Exit
ESC: Exit

Version 2.11.1210. Copyright (C) 2011 American Megatrends, Inc.

```

BIOS Menu 12: Hardware Health Configuration

→ PC Health Status

The following system parameters and values are shown. The system parameters that are monitored are:

- System Temperatures:
 - CPU Temperature
 - System Temperature
- Fan Speeds:
 - CPU Fan Speed
 - System Fan Speed
- Voltages:
 - VCC3V
 - V_core
 - +1.05V
 - VDDR
 - VSB3V
 - VBAT
 - 5VSB

KINO-AH612

5.3.8.1 FAN 1 Configuration

Use the **FAN 1 Configuration** submenu (**BIOS Menu 13**) to configure fan 1 temperature and speed settings.

```

Aptio Setup Utility - Copyright (C) 2011 American Megatrends, Inc.
-----
Advanced
-----
PC Health Status
CPU Smart Fan control          [Auto by RPM]
Target Temp. Sensor           [CPU Temperature]
Temperature Bound 1           60
Temperature Bound 2           50
Temperature Bound 3           40
Temperature Bound 4           30
Segment 1 Speed (%)           100
Segment 2 Speed (%)           85
Segment 3 Speed (%)           70
Segment 4 Speed (%)           60
Segment 5 Speed (%)           50
Full Speed Count              3000
-----
<=>: Select Screen
↑↓: Select Item
Enter>Select
+/-: Change Opt.
F1: General Help
F2: Previous Values
F3: Optimized Defaults
F4: Save & Exit
ESC: Exit
-----
Version 2.11.1210. Copyright (C) 2011 American Megatrends, Inc.
  
```

BIOS Menu 13: FAN 1 Configuration

→ CPU Smart Fan control [Auto by RPM]

Use the **CPU Smart Fan control** option to configure the CPU Smart Fan.

- **Auto by RPM** **DEFAULT** The fan adjusts its speed using Auto by RPM settings
- **Auto by Duty-Cycle** The fan adjusts its speed using Auto by Duty-Cycle settings
- **Manual by RPM** The fan spins at the speed set in Manual by RPM settings
- **Manual by Duty-Cycle** The fan spins at the speed set in Manual by Duty-Cycle settings

→ **Target Temp. Sensor [CPU Temperature]**

Use the **Target Temp. Sensor** option to set the target CPU temperature.

- | | | | |
|---|----------------------------|----------------|------------------------------------------------------------------------|
| → | CPU Temperature | DEFAULT | Sets the target temperature sensor to the CPU temperature. |
| → | System Temperature1 | | Sets the target temperature sensor to the System Temperature1 setting. |
| → | System Temperature2 | | Sets the target temperature sensor to the System Temperature2 setting. |

→ **Temperature Bound n**

Use the + or – key to change the fan **Temperature Bound n** value. Enter a decimal number between 0 and 127.

→ **Segment n Speed (%)**

Use the + or – key to change the fan **Segment n Speed** value in percentage. Enter a decimal number between 0 and 100.

→ **Full Speed Count**

Use the + or – key to change the fan **Full Speed Count** value. Enter a decimal number between 500 and 15000.

5.3.8.2 FAN 2 Configuration

Use the **FAN 2 Configuration** submenu (**BIOS Menu 14**) to configure fan 2 temperature and speed settings.

KINO-AH612

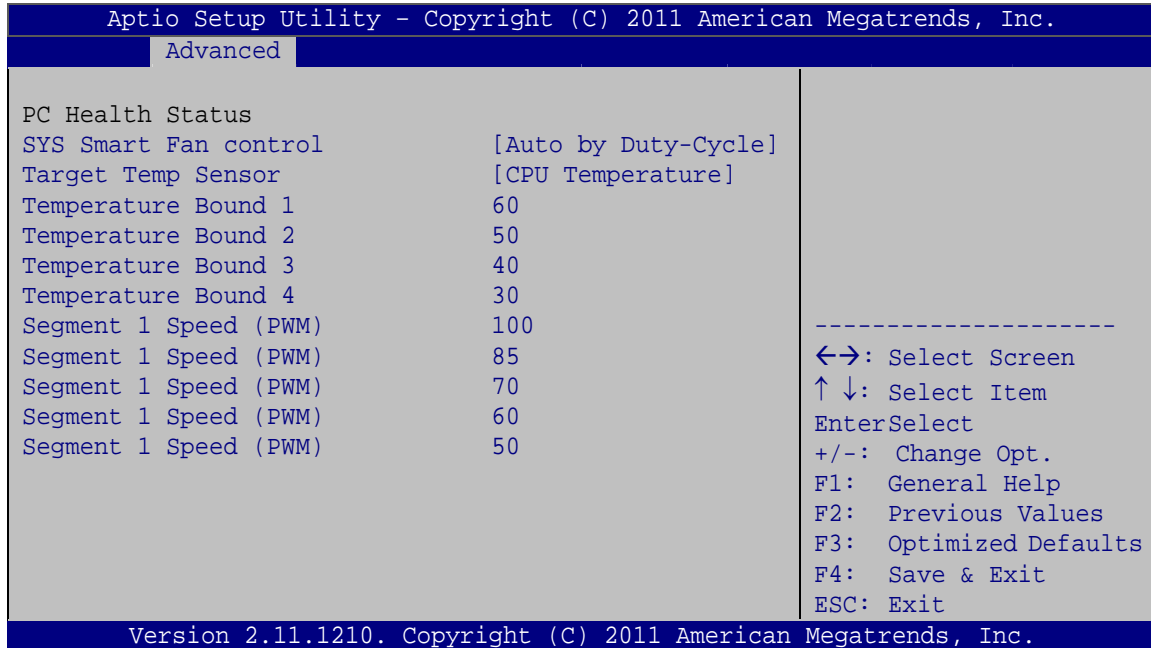

BIOS Menu 14: FAN 2 Configuration

→ CPU Smart Fan control [Auto by Duty-Cycle]

Use the **CPU Smart Fan control** option to configure the CPU Smart Fan.

- **Auto by RPM** The fan adjusts its speed using Auto by RPM settings
- **Auto by DEFAULT Duty-Cycle** The fan adjusts its speed using Auto by Duty-Cycle settings
- **Manual by RPM** The fan spins at the speed set in Manual by RPM settings
- **Manual by Duty-Cycle** The fan spins at the speed set in Manual by Duty-Cycle settings

→ Target Temp. Sensor [CPU Temperature]

Use the **Target Temp. Sensor** option to set the target CPU temperature.

- **CPU Temperature** **DEFAULT** Sets the target temperature sensor to the CPU temperature.

- **System Temperature1** Sets the target temperature sensor to the System Temperature1 setting.
- **System Temperature2** Sets the target temperature sensor to the System Temperature2 setting.

→ **Temperature Bound n**

Use the + or – key to change the fan **Temperature Bound n** value. Enter a decimal number between 0 and 127.

→ **Segment 1 Speed (PWM)**

Use the + or – key to change the fan **Segment n Speed** value in Pulse Width Modulation (PWM). Enter a decimal number between 0 and 100.

5.3.9 Serial Port Console Redirection

The **Serial Port Console Redirection** menu (**BIOS Menu 15**) allows the console redirection options to be configured. Console redirection allows users to maintain a system remotely by re-directing keyboard input and text output through the serial port.

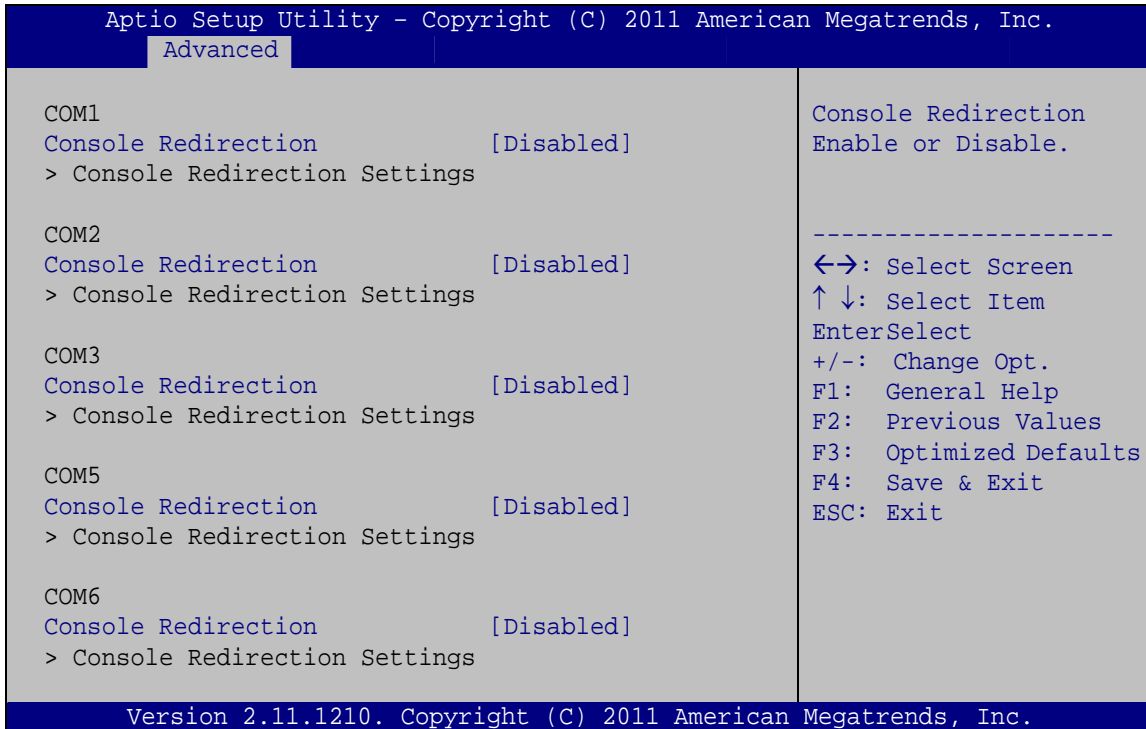

BIOS Menu 15: Serial Port Console Redirection Menu

→ Console Redirection

Use **Console Redirection** option to enable or disable the console redirection function.

- **Disabled** **DEFAULT** Disabled the console redirection function
- **Enabled** Enabled the console redirection function

5.3.10 IEI Feature

Use the **IEI Feature** menu (**BIOS Menu 16**) to configure One Key Recovery function.

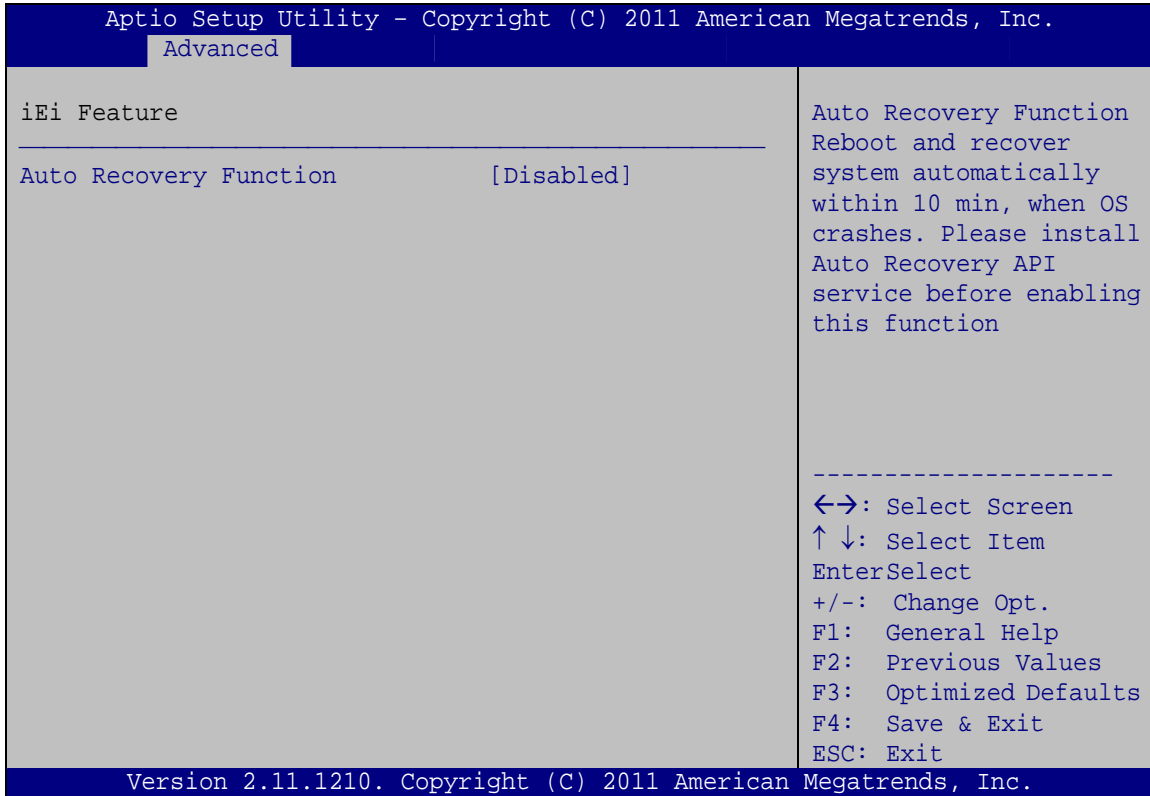
BIOS Menu 16: IEI Feature
→ Auto Recovery Function [Disabled]

Use the **Auto Recovery Function** BIOS option to enable or disable the auto recovery function of the IEI One Key Recovery.

- **Disabled** **DEFAULT** Auto recovery function disabled
- **Enabled** Auto recovery function enabled

5.4 Chipset

Use the **Chipset** menu (**BIOS Menu 17**) to access the Northbridge and Southbridge configuration menus



WARNING!

Setting the wrong values for the Chipset BIOS selections in the Chipset BIOS menu may cause the system to malfunction.

```

Aptio Setup Utility - Copyright (C) 2011 American Megatrends, Inc.
Main   Advanced  Chipset  Boot   Security  Save & Exit
-----
> North Bridge           North Bridge Parameters
> South Bridge
> Integrated Graphics

-----
<=>: Select Screen
↑ ↓: Select Item
EnterSelect
+/-: Change Opt.
F1:  General Help
F2:  Previous Values
F3:  Optimized Defaults
F4:  Save & Exit
ESC: Exit

V Version 2.11.1210. Copyright (C) 2011 American Megatrends, Inc.
    
```

BIOS Menu 17: Chipset

5.4.1 Northbridge Configuration

Use the **Northbridge Chipset Configuration** menu (**BIOS Menu 18**) to configure the Northbridge chipset.

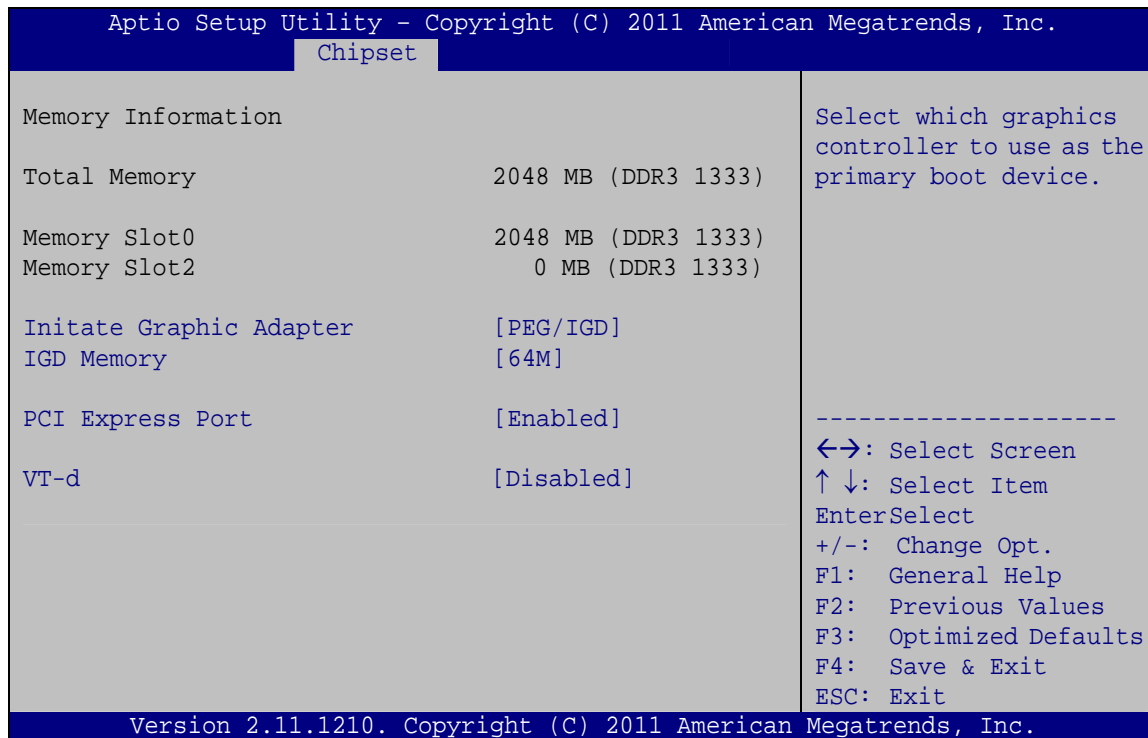

BIOS Menu 18: Northbridge Chipset Configuration

→ Initiate Graphic Adapter [PEG/IGD]

Use the **Initiate Graphic Adapter** option to select the graphics controller used as the primary boot device. Select either an integrated graphics controller (IGD) or a combination of PCI graphics controller, a PCI express (PEG) controller or an IGD. Configuration options are listed below:

- IGD
- PEG/IGD DEFAULT

→ IGD Memory [64 M]

Use the **IGD Memory** option to specify the amount of system memory that can be used by the Internal graphics device.

KINO-AH612

→	Disable		
→	32 M		32 MB of memory used by internal graphics device
→	64 M	DEFAULT	64 MB of memory used by internal graphics device
→	96 M		96 MB of memory used by internal graphics device
→	128 M		128 MB of memory used by internal graphics device
→	160 M		160 MB of memory used by internal graphics device
→	192 M		192 MB of memory used by internal graphics device
→	224 M		224 MB of memory used by internal graphics device
→	256 M		256 MB of memory used by internal graphics device
→	288 M		288 MB of memory used by internal graphics device
→	320 M		320 MB of memory used by internal graphics device
→	352 M		352 MB of memory used by internal graphics device
→	384 M		384 MB of memory used by internal graphics device
→	416 M		416 MB of memory used by internal graphics device
→	448 M		448 MB of memory used by internal graphics device
→	480 M		480 MB of memory used by internal graphics device

→ **512 M** 512 MB of memory used by internal graphics device

→ **PCI Express Port [Enabled]**

Use the **PCI Express Port** option to enable or disable the PCI Express port.

→ **Disabled** Disables the PCI Express port.

→ **Enabled** **DEFAULT** Enables the PCI Express port.

→ **VT-d [Disabled]**

Use the **VT-d** option to enable or disable VT-d support.

→ **Disabled** **DEFAULT** Disables VT-d support.

→ **Enabled** Enables VT-d support.

5.4.2 Southbridge Configuration

Use the **Southbridge Configuration** menu (**BIOS Menu 19**) to configure the Southbridge chipset.

KINO-AH612

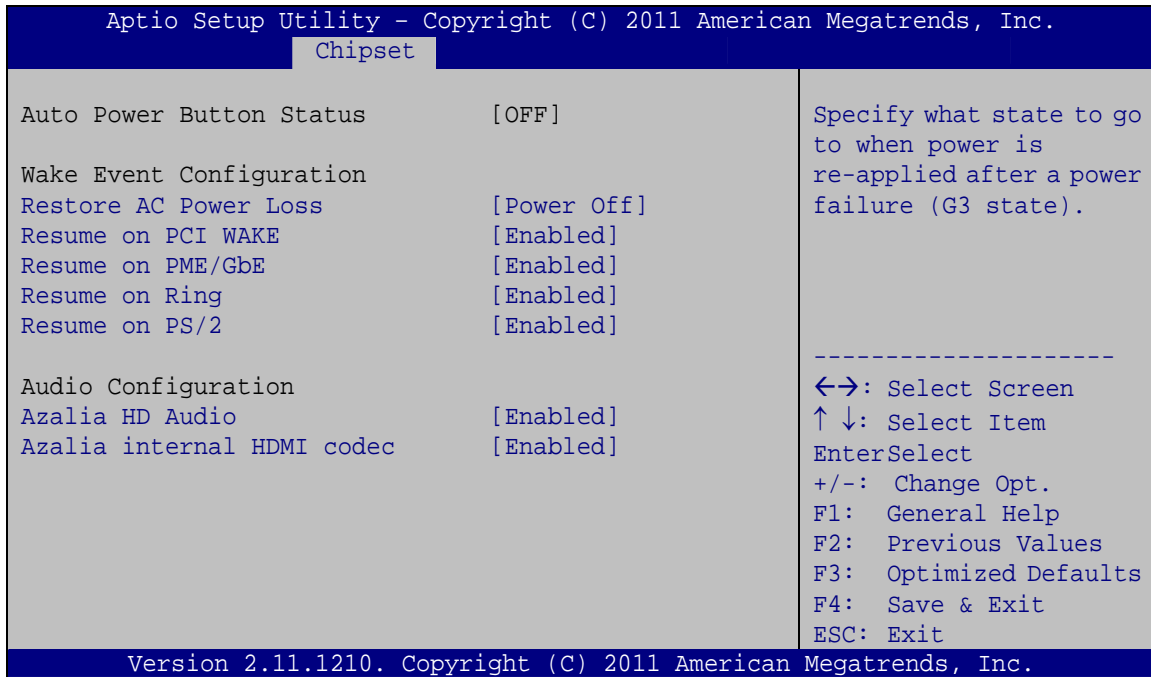

BIOS Menu 19: Southbridge Chipset Configuration

→ Restore AC on Power Loss [Power Off]

Use the **Restore AC on Power Loss** option to specify what state the system returns to if there is a sudden loss of power to the system.

- **Power Off** **DEFAULT** The system remains turned off
- **Power On** The system turns on
- **Last State** The system returns to its previous state. If it was on, it turns itself on. If it was off, it remains off.

→ Resume on PCIE Wake [Enabled]

Use the **Resume on PCIE Wake** option specifies if the system is roused from a suspended or standby state when there is activity on the LAN.

- **Disabled** Disables Resume on PCIe Wake
- **Enabled** **DEFAULT** Enables Resume on PCIe Wake

→ **Resume on PME/GbE [Enabled]**

Use the **Resume on PME/GbE** option to enable or disable resuming from PCI PME#, on-chip GbE controller, or other on-chip devices.

- **Disabled** Disables Resume on PME/GbE option
- **Enabled** **DEFAULT** Enables Resume on PME/GbE option

→ **Resume on Ring [Enabled]**

Use the **Resume on Ring** option to enable or disable resuming from RI# signal.

- **Disabled** Disables Resume on Ring option
- **Enabled** **DEFAULT** Enables Resume on Ring option

→ **Resume on PS/2 [Enabled]**

Use the **Resume on PS/2** option to enable or disable resuming from PS/2 activation.

- **Disabled** Disables Resume on PS/2 option
- **Enabled** **DEFAULT** Enables Resume on PS/2 option

→ **Azalia HD Audio [Enabled]**

Use the **Azalia HD Audio** option to enable or disable the High Definition Audio controller.

- **Disabled** The onboard High Definition Audio controller is disabled
- **Enabled** **DEFAULT** The onboard High Definition Audio controller is detected automatically and enabled

→ **Azalia internal HDMI codec [Enabled]**

Use the **Azalia internal HDMI codec** option to enable or disable the internal HDMI codec for High Definition Audio.

- **Disabled** Disables the internal HDMI codec for High Definition Audio

KINO-AH612

- ➔ **Enabled** **DEFAULT** Enables the internal HDMI codec for High Definition Audio

5.4.3 Integrated Graphics

Use the **Integrated Graphics** menu (**BIOS Menu 20**) to configure the video device connected to the system.

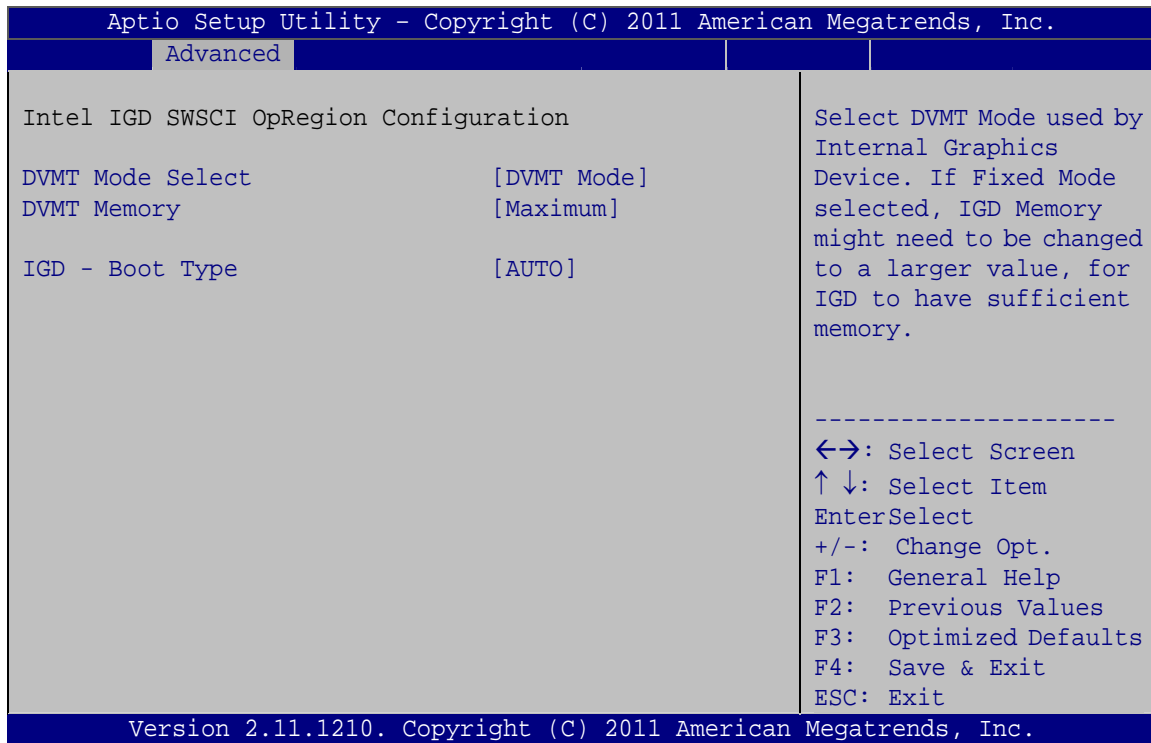

BIOS Menu 20: Integrated Graphics

➔ DVMT Mode Select [DVMT Mode]

Use the **DVMT Mode Select** option to select the Intel Dynamic Video Memory Technology (DVMT) operating mode.

- ➔ **Fixed Mode** A fixed portion of graphics memory is reserved as graphics memory.
- ➔ **DVMT Mode** **DEFAULT** Graphics memory is dynamically allocated according to the system and graphics needs.

→ DVMT Memory [Maximum]

Use the **DVMT Memory** option to specify the maximum amount of memory that can be allocated as graphics memory. Configuration options are listed below.

- 128 MB
- 256 MB
- Maximum **DEFAULT**

→ IGD - Boot Type [AUTO]

Use the **IGD - Boot Type** option to select the display device used by the system when it boots. For dual display support, select "Auto." Configuration options are listed below.

- AUTO **DEFAULT**
- CRT 1
- CRT 2
- HDMI 1
- HDMI 2

5.5 Boot

Use the **Boot** menu (**BIOS Menu 21**) to configure system boot options.

```

Aptio Setup Utility - Copyright (C) 2011 American Megatrends, Inc.
Main   Advanced  Chipset  Boot   Security  Save & Exit
-----
Boot Configuration
Bootup NumLock State      [On]
Quiet Boot                 [Enabled]
Launch PXE OpROM          [Disabled]
Option ROM Messages       [Force BIOS]

Boot Option Priorities

-----
Select the keyboard NumLock state

-----
<->: Select Screen
↑ ↓: Select Item
Enter>Select
+/-: Change Opt.
F1:  General Help
F2:  Previous Values
F3:  Optimized Defaults
F4:  Save & Exit
ESC: Exit

Version 2.11.1210. Copyright (C) 2011 American Megatrends, Inc.

```

BIOS Menu 21: Boot

KINO-AH612

→ **Bootup NumLock State [On]**

Use the **Bootup NumLock State** BIOS option to specify if the number lock setting must be modified during boot up.

- **On** **DEFAULT** Allows the Number Lock on the keyboard to be enabled automatically when the computer system boots up. This allows the immediate use of the 10-key numeric keypad located on the right side of the keyboard. To confirm this, the Number Lock LED light on the keyboard is lit.

- **Off** Does not enable the keyboard Number Lock automatically. To use the 10-keys on the keyboard, press the Number Lock key located on the upper left-hand corner of the 10-key pad. The Number Lock LED on the keyboard lights up when the Number Lock is engaged.

→ **Quiet Boot [Enabled]**

Use the **Quiet Boot** BIOS option to select the screen display when the system boots.

- **Disabled** Normal POST messages displayed

- **Enabled** **DEFAULT** OEM Logo displayed instead of POST messages

→ **Launch PXE OpROM [Disabled]**

Use the **Launch PXE OpROM** option to enable or disable boot option for legacy network devices.

- **Disabled** Ignore all PXE Option ROMs

- **Enabled** **DEFAULT** Load PXE Option ROMs

→ **Option ROM Messages [Keep Current]**

Use the **Option ROM Messages** option to set the Option ROM display mode.

- **Force BIOS** Sets display mode to force BIOS.
- **Keep Current** **DEFAULT** Sets display mode to current.

5.6 Security

Use the **Security** menu (**BIOS Menu 22**) to set system and user passwords.

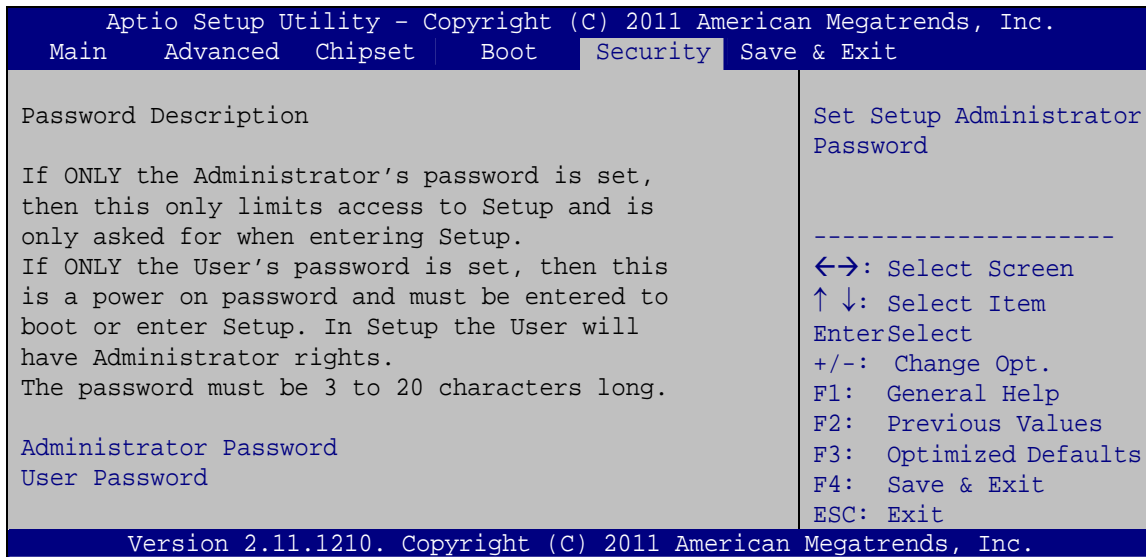

BIOS Menu 22: Security

→ Administrator Password

Use the **Administrator Password** to set or change an administrator password.

→ User Password

Use the **User Password** to set or change a user password.

KINO-AH612

5.7 Save & Exit

Use the **Save & Exit** menu (**BIOS Menu 23**) to load default BIOS values, optimal failsafe values and to save configuration changes.

```

Aptio Setup Utility - Copyright (C) 2011 American Megatrends, Inc.
Main   Advanced  Chipset  Boot   Security  Save & Exit

Save Changes and Reset
Discard Changes and Reset

Restore Defaults
Save as User Defaults
Restore User Defaults

Reset the system after
saving the changes.

-----
<->: Select Screen
↑ ↓: Select Item
Enter>Select
+/-: Change Opt.
F1:  General Help
F2:  Previous Values
F3:  Optimized Defaults
F4:  Save & Exit
ESC: Exit

Version 2.11.1210. Copyright (C) 2011 American Megatrends, Inc.

```

BIOS Menu 23:Exit

→ Save Changes and Reset

Use the **Save Changes and Reset** option to save the changes made to the BIOS options and to exit the BIOS configuration setup program.

→ Discard Changes and Reset

Use the **Discard Changes and Reset** option to exit the system without saving the changes made to the BIOS configuration setup program.

→ Restore Defaults

Use the **Restore Defaults** option to load the optimal default values for each of the parameters on the Setup menus. **F3 key can be used for this operation.**

→ **Save as User Defaults**

Use the **Save as User Defaults** option to save the changes done so far as user defaults.

→ **Restore User Defaults**

Use the **Restore User Defaults** option to restore the user defaults to all the setup options.

Chapter

6

Software Drivers

6.1 Available Software Drivers



NOTE:

The content of the CD may vary throughout the life cycle of the product and is subject to change without prior notice. Visit the IEI website or contact technical support for the latest updates.

The following drivers can be installed on the system:

- Chipset
- Graphic
- LAN
- Audio

Installation instructions are given below.

6.2 Software Installation

All the drivers for the KINO-AH612 are on the CD that came with the system. To install the drivers, please follow the steps below.

Step 1: Insert the CD into a CD drive connected to the system.



NOTE:

If the installation program doesn't start automatically:
Click "Start->My Computer->CD Drive->autorun.exe"

Step 2: The driver main menu appears (**Figure 6-1**).

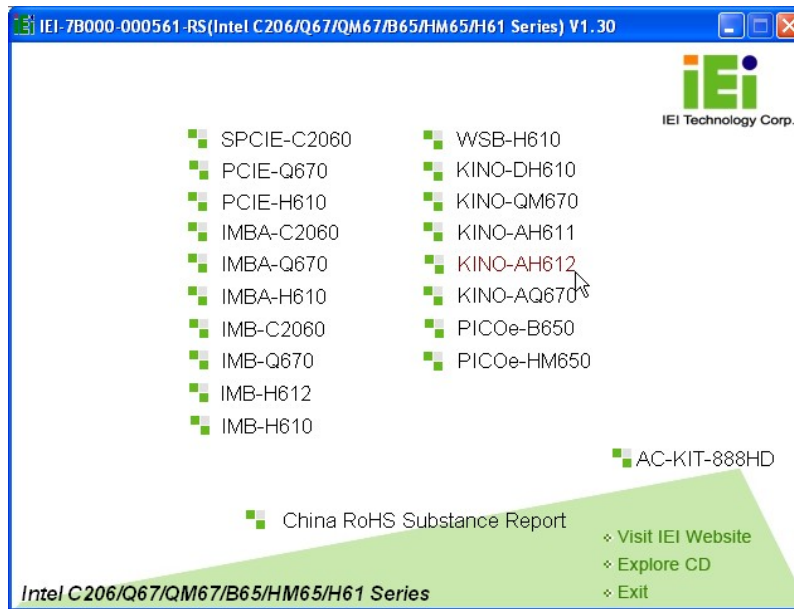

Figure 6-1: Introduction Screen

Step 3: Click KINO-AH612.

Step 4: A new screen with a list of available drivers appears (Figure 6-2).

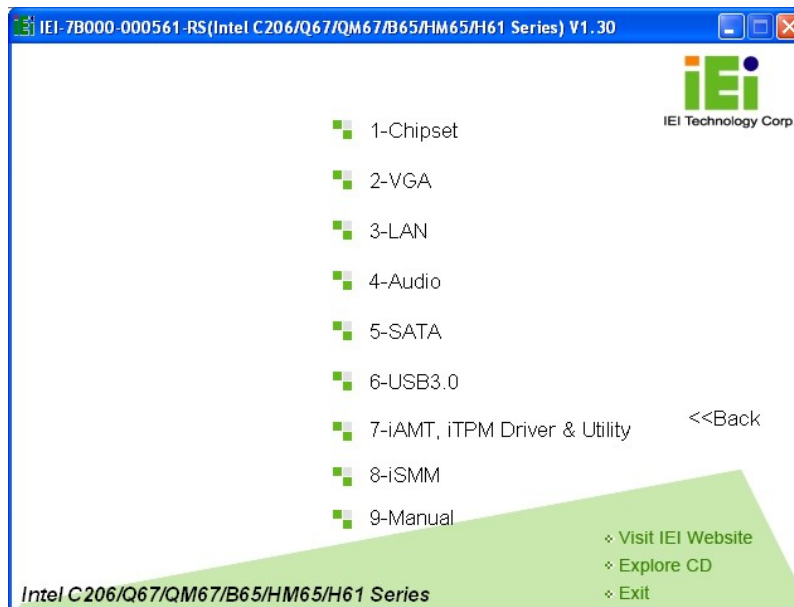

Figure 6-2: Available Drivers

Step 5: Install all of the necessary drivers in this menu.



Appendix

A

BIOS Menu Options

BIOS Information	60
Memory Information	60
System Date [xx/xx/xx]	61
System Time [xx:xx:xx]	61
ACPI Sleep State [S1 (CPU Stop Clock)]	63
TPM Support [Disable]	64
Intel Virtualization Technology [Disabled]	64
SATA Mode [IDE Mode]	66
Serial-ATA Controller 0 [Compatible]	66
Serial-ATA Controller 1 [Enhanced]	67
USB Devices	68
USB Support [Enabled]	69
Power Saving Function [Disabled]	69
Serial Port [Enabled]	70
Change Settings [Auto]	70
Serial Port [Enabled]	71
Change Settings [Auto]	71
Serial Port [Enabled]	72
Change Settings [Auto]	72
Serial Port [Enabled]	73
Change Settings [Auto]	73
Device Mode [RS422/485]	73
Serial Port [Enabled]	74
Change Settings [Auto]	74
Serial Port [Enabled]	75
Change Settings [Auto]	75
PC Health Status	76
CPU Smart Fan control [Auto by RPM]	77
Target Temp. Sensor [CPU Temperature]	78
Temperature Bound n	78
Segment n Speed (%)	78
Full Speed Count	78
CPU Smart Fan control [Auto by Duty-Cycle]	79
Target Temp. Sensor [CPU Temperature]	79

Temperature Bound n.....	80
Segment 1 Speed (PWM).....	80
Console Redirection	81
Auto Recovery Function [Disabled].....	82
Initiate Graphic Adapter [PEG/IGD].....	84
IGD Memory [64 M]	84
PCI Express Port [Enabled]	86
VT-d [Disabled].....	86
Restore AC on Power Loss [Power Off]	87
Resume on PCIE Wake [Enabled]	87
Resume on PME/GbE [Enabled].....	88
Resume on Ring [Enabled]	88
Resume on PS/2 [Enabled]	88
Azalia HD Audio [Enabled].....	88
Azalia internal HDMI codec [Enabled]	88
DVMT Mode Select [DVMT Mode].....	89
DVMT Memory [Maximum].....	90
IGD - Boot Type [AUTO]	90
Bootup NumLock State [On].....	91
Quiet Boot [Enabled]	91
Launch PXE OpROM [Disabled]	91
Option ROM Messages [Keep Current]	91
Administrator Password	92
User Password	92
Save Changes and Reset	93
Discard Changes and Reset	93
Restore Defaults	93
Save as User Defaults	94
Restore User Defaults	94

Appendix

B

One Key Recovery

B.1 One Key Recovery Introduction

The IEI one key recovery is an easy-to-use front end for the Norton Ghost system backup and recovery tool. This tool provides quick and easy shortcuts for creating a backup and reverting to that backup or reverting to the factory default settings.



NOTE:

The latest One Key Recovery software provides an auto recovery function that allows a system running Microsoft Windows OS to automatically restore from the factory default image after encountering a Blue Screen of Death (BSoD) or a hang for around 10 minutes. Please refer to Section B.3 for the detailed setup procedure.

The IEI One Key Recovery tool menu is shown below.

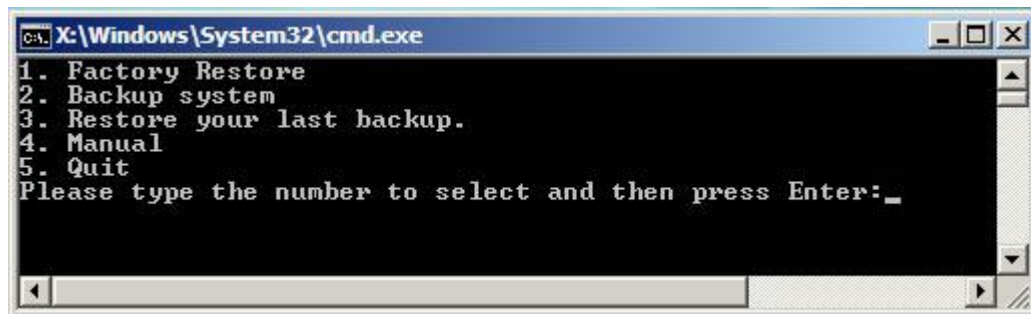

```
C:\X:\Windows\System32\cmd.exe
1. Factory Restore
2. Backup system
3. Restore your last backup.
4. Manual
5. Quit
Please type the number to select and then press Enter: _
```

Figure B-1: IEI One Key Recovery Tool Menu

Prior to using the IEI One Key Recovery tool (as shown in **Figure B-1**) to backup or restore Windows system, five setup procedures are required.

3. Hardware and BIOS setup (see **Section B.2.1**)
4. Create partitions (see **Section B.2.2**)
5. Install operating system, drivers and system applications (see **Section B.2.3**)
6. Build the recovery partition (see **Section B.2.4**)
7. Create factory default image (see **Section B.2.5**)

KINO-AH612

After completing the five initial setup procedures as described above, users can access the recovery tool by pressing <F3> while booting up the system. The detailed information of each function is described in **Section B.5**.



NOTE:

The initial setup procedures for Linux system are described in **Section B.3**.

B.1.1 System Requirement



NOTE:

The recovery CD can only be used with IEI products. The software will fail to run and a warning message will appear when used on non-IEI hardware.

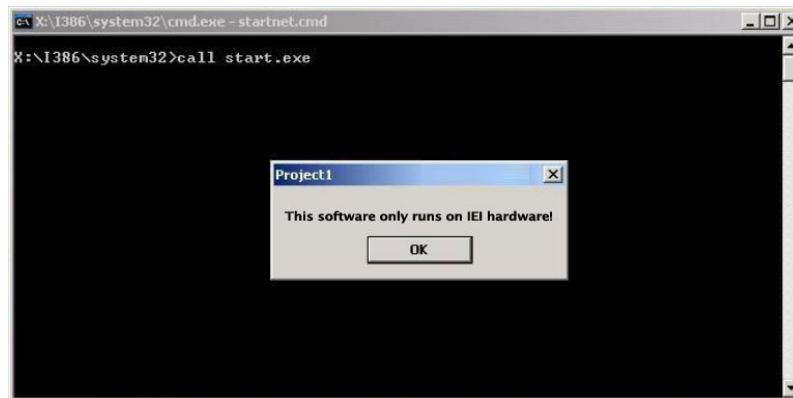

To create the system backup, the main storage device must be split into two partitions (three partitions for Linux). The first partition will be for the operating system, while the second partition will be invisible to the operating system and contain the backup made by the one key recovery software.

The partition created for recovery images must be big enough to contain both the factory default image and the user backup image. The size must be calculated before creating the

partitions. Please take the following table as a reference when calculating the size of the partition.

	OS	OS Image after Ghost	Compression Ratio
Windows® 7	7 GB	5 GB	70%
Windows® XPE	776 MB	560 MB	70%
Windows® CE 6.0	36 MB	28 MB	77%

NOTE:

Specialized tools are required to change the partition size if the operating system is already installed.

B.1.2 Supported Operating System

The recovery CD is compatible with both Microsoft Windows and Linux operating systems (OS). The supported OS versions are listed below.

- Microsoft Windows
 - Windows 2000
 - Windows XP (Service Pack 2 or 3 required)
 - Windows Vista
 - Windows 7
 - Windows CE 5.0
 - Windows CE 6.0
 - Windows XP Embedded
 - Windows Embedded Standard 7

NOTE:

The auto recovery function (described in Section B.3) and the restore through LAN function (described in Section B.6) are not supported in the Windows CE 5.0/6.0 operating system environment.

KINO-AH612

- Linux
 - Fedora Core 12 (Constantine)
 - Fedora Core 11 (Leonidas)
 - Fedora Core 10 (Cambridge)
 - Fedora Core 8 (Werewolf)
 - Fedora Core 7 (Moonshine)
 - RedHat RHEL-5.4
 - RedHat 9 (Ghirke)
 - Ubuntu 8.10 (Intrepid)
 - Ubuntu 7.10 (Gutsy)
 - Ubuntu 6.10 (Edgy)
 - Debian 5.0 (Lenny)
 - Debian 4.0 (Etch)
 - SuSe 11.2
 - SuSe 10.3



NOTE:

Installing unsupported OS versions may cause the recovery tool to fail.

B.2 Setup Procedure for Windows

Prior to using the recovery tool to backup or restore, a few setup procedures are required.

Step 1: Hardware and BIOS setup (see **Section B.2.1**)

Step 2: Create partitions (see **Section B.2.2**)

Step 3: Install operating system, drivers and system applications (see **Section B.2.3**)

Step 4: Build the recovery partition (see **Section B.2.4**) or build the auto recovery partition (see **Section B.3**)

Step 5: Create factory default image (see **Section B.2.5**)

The detailed descriptions are described in the following sections.

**NOTE:**

The setup procedures described below are for Microsoft Windows operating system users. For Linux, most of the setup procedures are the same except for several steps described in **Section B.3**.

B.2.1 Hardware and BIOS Setup

- Step 1:** Make sure the system is powered off and unplugged.
- Step 2:** Install a hard drive or SSD in the system. An unformatted and unpartitioned disk is recommended.
- Step 3:** Connect an optical disk drive to the system and insert the recovery CD.
- Step 4:** Turn on the system.
- Step 5:** Press the <DELETE> key as soon as the system is turned on to enter the BIOS.
- Step 6:** Select the connected optical disk drive as the 1st boot device. (**Boot** → **Boot Device Priority** → **1st Boot Device**).
- Step 7:** Save changes and restart the computer. Continue to the next section for instructions on partitioning the internal storage.

B.2.2 Create Partitions

To create the system backup, the main storage device must be split into two partitions (three partitions for Linux). The first partition will be for the operating system, while the second partition will be invisible to the operating system and contain the backup made by the one key recovery software.

- Step 1:** Put the recovery CD in the optical drive of the system.

KINO-AH612

Step 2: Boot the system from recovery CD. When prompted, press any key to boot from the recovery CD. It will take a while to launch the recovery tool. Please be patient!

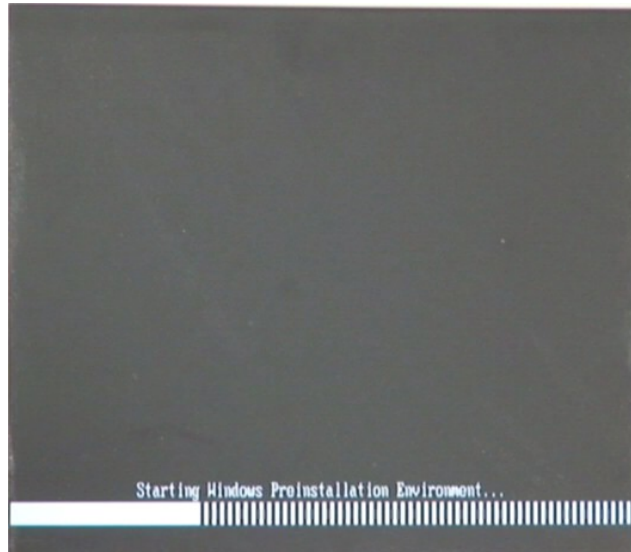

Figure B-2: Launching the Recovery Tool

Step 3: The recovery tool setup menu is shown as below.

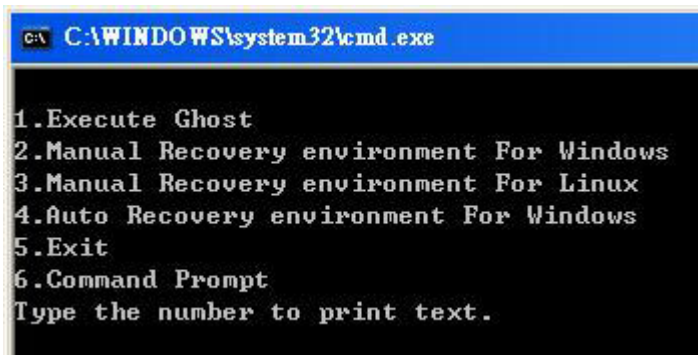
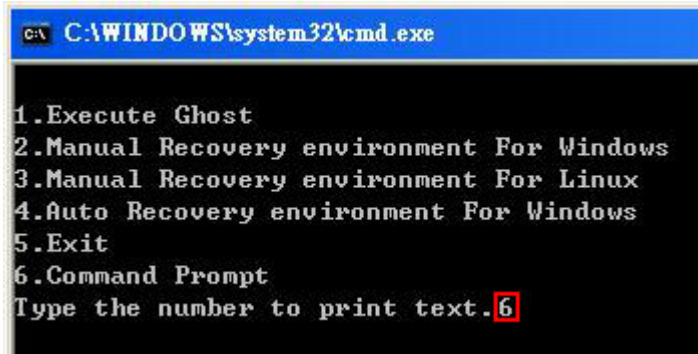

Figure B-3: Recovery Tool Setup Menu

Step 4: Press <6> then <Enter>.



```
C:\WINDOWS\system32\cmd.exe

1.Execute Ghost
2.Manual Recovery environment For Windows
3.Manual Recovery environment For Linux
4.Auto Recovery environment For Windows
5.Exit
6.Command Prompt
Type the number to print text.6
```

Figure B-4: Command Prompt

Step 5: The command prompt window appears. Type the following commands (marked in red) to create two partitions. One is for the OS installation; the other is for saving recovery files and images which will be an invisible partition. (Press <Enter> after entering each line below)

```
system32>diskpart
DISKPART>list vol
DISKPART>sel disk 0
DISKPART>create part pri size= ____
DISKPART>assign letter=N
DISKPART>create part pri size= ____
DISKPART>assign letter=F
DISKPART>exit
system32>format N: /fs:ntfs /q /y
system32>format F: /fs:ntfs /q /v:Recovery /y
system32>exit
```

```

X:\I386\SYSTEM32\CMD.EXE
X:\I386\SYSTEM32>diskpart → Starts the Microsoft disk partitioning tool.

Microsoft DiskPart version 5.2.3790.1830
Copyright (C) 1999-2001 Microsoft Corporation.
On computer: MININT-JUC

DISKPART> list vol → Show partition information

   Volume ###  Ltr  Label          Fs          Type          Size         Status       Info
   -----  -  -  -  -  -  -  -  -  -
   Volume 0             X   CD_ROM        CDFS        DUD-ROM       405 MB       Healthy      Boot
   Volume 1             D                   FAT32      Removeable   3854 MB       Healthy

DISKPART> sel disk 0 → Select a disk
Disk 0 is now the selected disk.

DISKPART> create part pri size=2000 → Create partition 1 and assign a size.
                                     This partition is for OS installation.
DiskPart succeeded in creating the specified partition.

DISKPART> assign letter=N → Assign partition 1 a code name (N).
DiskPart successfully assigned the drive letter or mount point.

DISKPART> create part pri size=1800 → Create partition 2 and assign a size.
                                     This partition is for recovery images.
DiskPart succeeded in creating the specified partition.

DISKPART> assign letter=F → Assign partition 2 a code name (F).
DiskPart successfully assigned the drive letter or mount point.

DISKPART> exit → Exit diskpart

X:\I386\SYSTEM32>format n: /fs:ntfs /q /y → Format partition 1 (N) as NTFS format.
The type of the file system is RAW.
The new file system is NTFS.
QuickFormatting 2000M
Creating file system structures.
Format complete.
 2048254 KB total disk space.
 2035620 KB are available.

X:\I386\SYSTEM32>format f: /fs:ntfs /q /v:Recovery /y
The type of the file system is RAW.
The new file system is NTFS.
QuickFormatting 1804M
Creating file system structures.
Format complete.
 1847474 KB total disk space.
 1835860 KB are available.

X:\I386\SYSTEM32>exit → Exit Windows PE
  
```

Figure B-5: Partition Creation Commands

NOTE:

Use the following commands to check if the partitions were created successfully.

```

X:\I386\SYSTEM32>diskpart
Microsoft DiskPart version 5.2.3790.1830
Copyright (C) 1999-2001 Microsoft Corporation.
On computer: MININT-JUC
DISKPART> sel disk 0
Disk 0 is now the selected disk.
DISKPART> list part
   Partition ###  Type              Size              Offset
-----
   Partition 1    Primary           2000 MB           32 KB
   Partition 2    Primary           1804 MB          2000 MB
DISKPART> exit
  
```

Step 6: Press any key to exit the recovery tool and automatically reboot the system.

Please continue to the following procedure: Build the Recovery Partition.

B.2.3 Install Operating System, Drivers and Applications

Install the operating system onto the unlabelled partition. The partition labeled "Recovery" is for use by the system recovery tool and should not be used for installing the operating system or any applications.

NOTE:

The operating system installation program may offer to reformat the chosen partition. DO NOT format the partition again. The partition has already been formatted and is ready for installing the new operating system.

To install the operating system, insert the operating system installation CD into the optical drive. Restart the computer and follow the installation instructions.

KINO-AH612

B.2.4 Building the Recovery Partition

- Step 1:** Put the recover CD in the optical drive.
- Step 2:** Start the system.
- Step 3:** **Boot the system from the recovery CD.** When prompted, press any key to boot from the recovery CD. It will take a while to launch the recovery tool. Please be patient!

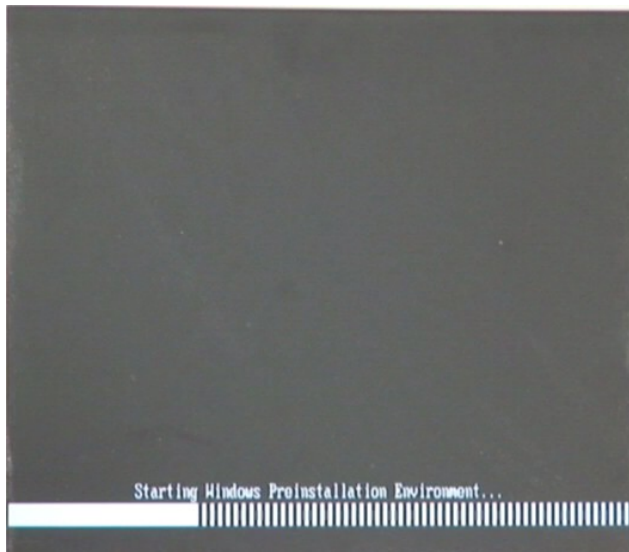
**Figure B-6: Launching the Recovery Tool**

- Step 4:** When the recovery tool setup menu appears, press <2> then <Enter>.

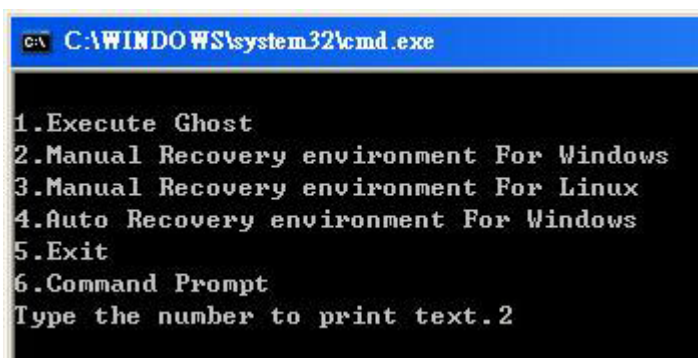
**Figure B-7: Manual Recovery Environment for Windows**

Step 5: The Symantec Ghost window appears and starts configuring the system to build a recovery partition. In this process the partition created for recovery files in **Section B.2.2** is hidden and the recovery tool is saved in this partition.

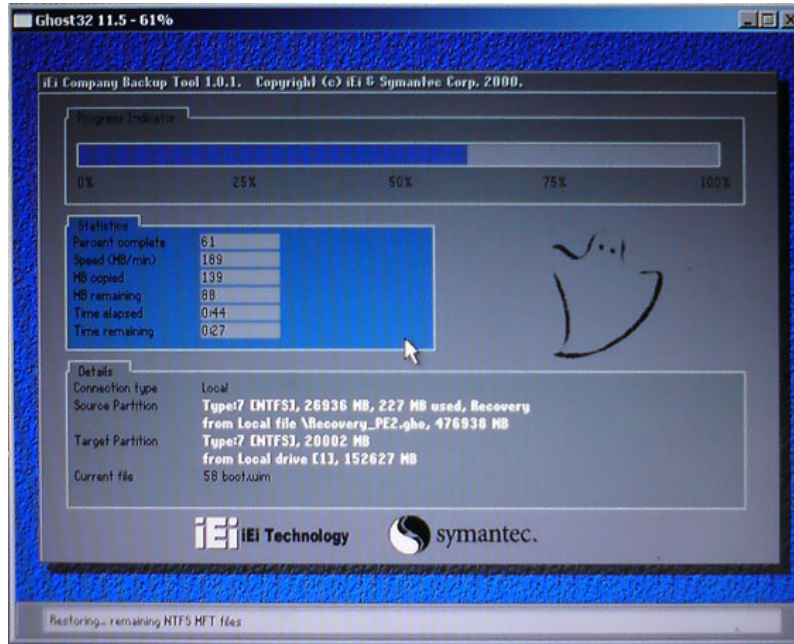

Figure B-8: Building the Recovery Partition

Step 6: After completing the system configuration, press any key in the following window to reboot the system.

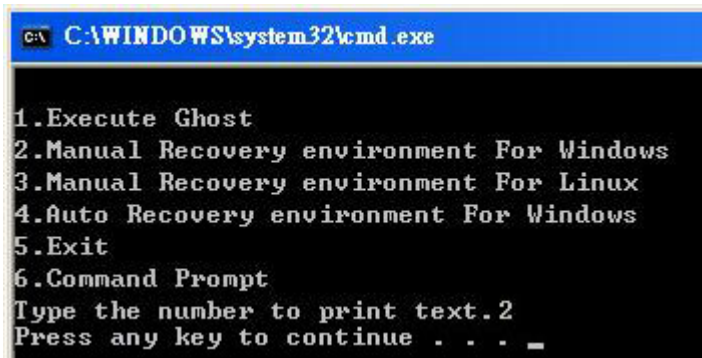

Figure B-9: Press Any Key to Continue

Step 7: Eject the recovery CD.

B.2.5 Create Factory Default Image



NOTE:

Before creating the factory default image, please configure the system to a factory default environment, including driver and application installations.

To create a factory default image, please follow the steps below.

Step 1: Turn on the system. When the following screen displays (**Figure B-10**), press the <F3> key to access the recovery tool. The message will display for 10 seconds, please press F3 before the system boots into the operating system.

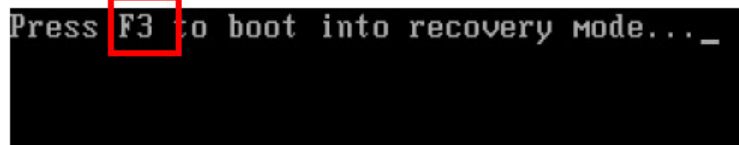

Figure B-10: Press F3 to Boot into Recovery Mode

Step 2: The recovery tool menu appears. Type <4> and press <Enter>. (**Figure B-11**)

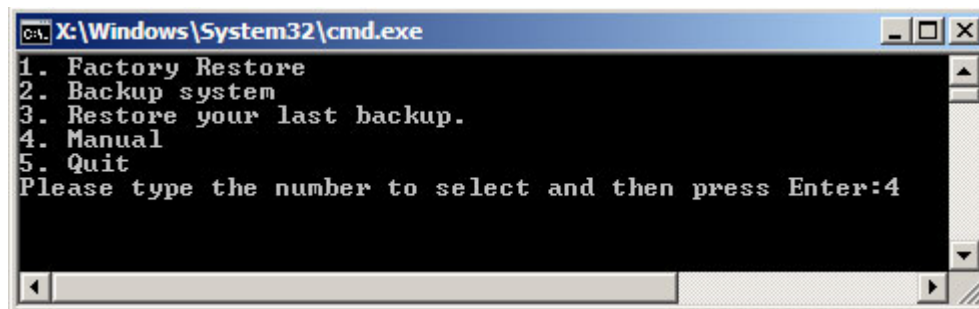

Figure B-11: Recovery Tool Menu

Step 3: The About Symantec Ghost window appears. Click **OK** button to continue.

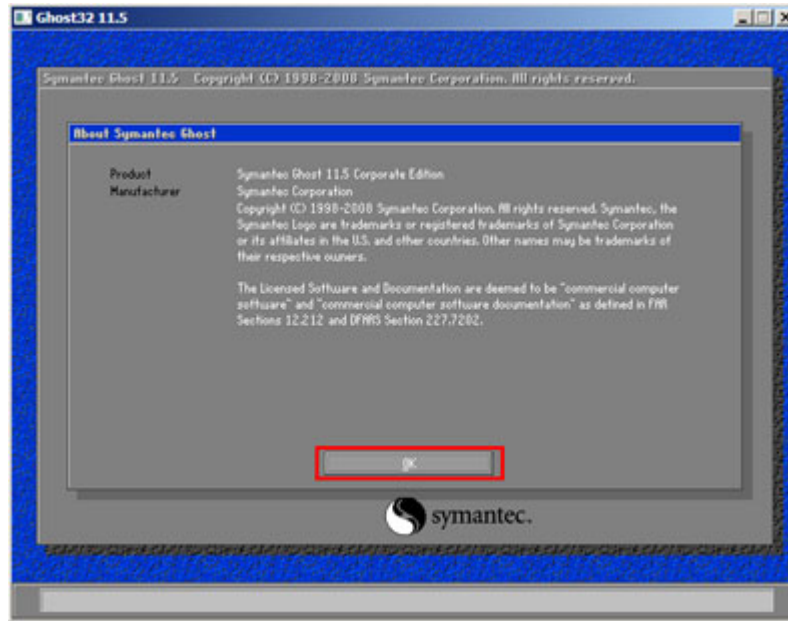

Figure B-12: About Symantec Ghost Window

Step 4: Use mouse to navigate to the option shown below (Figure B-13).

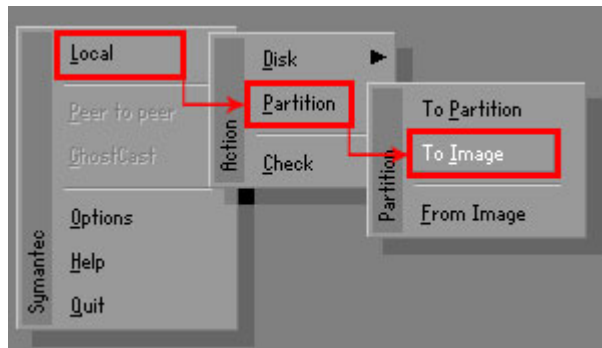

Figure B-13: Symantec Ghost Path

Step 5: Select the local source drive (Drive 1) as shown in Figure B-14. Then click OK.

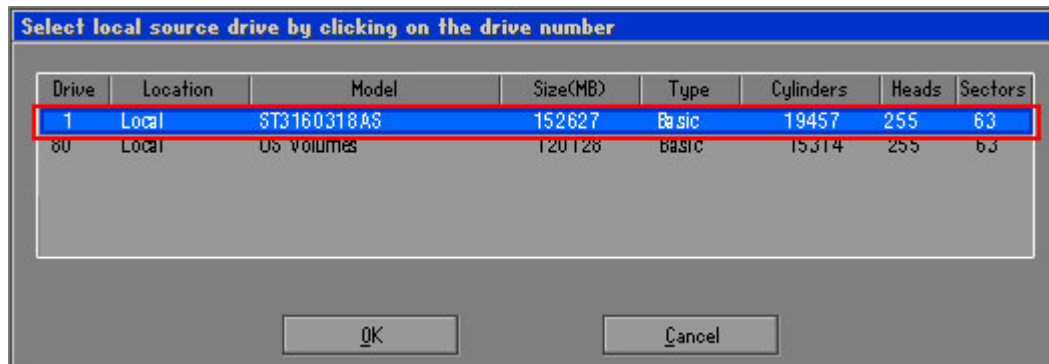

Figure B-14: Select a Local Source Drive

Step 6: Select a source partition (Part 1) from basic drive as shown in **Figure B-15**. Then click OK.

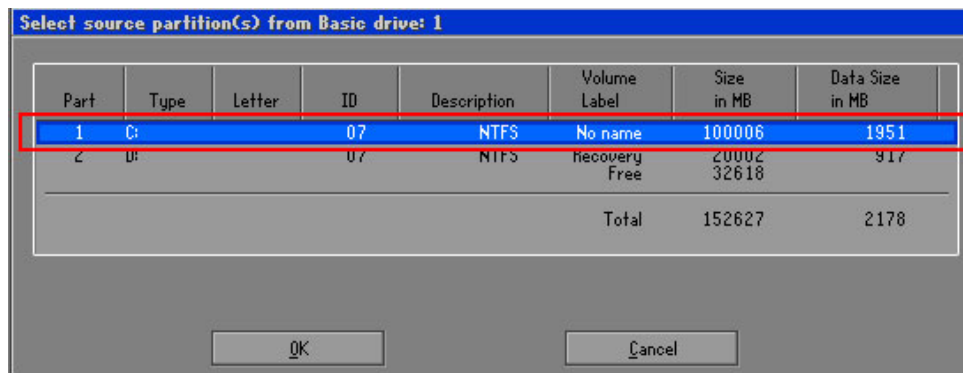

Figure B-15: Select a Source Partition from Basic Drive

Step 7: Select **1.2: [Recovery] NTFS drive** and enter a file name called **iei** (**Figure B-16**). Click **Save**. The factory default image will then be saved in the selected recovery drive and named **IEI.GHO**.



WARNING:

The file name of the factory default image must be **iei.GHO**.

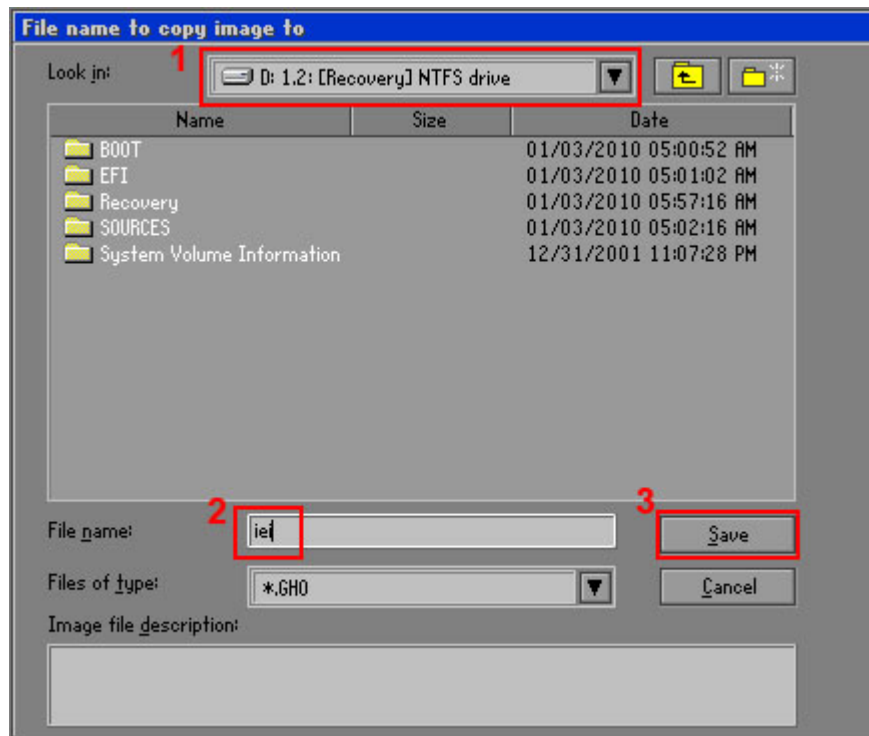

Figure B-16: File Name to Copy Image to

Step 8: When the Compress Image screen in **Figure B-17** prompts, click **High** to make the image file smaller.

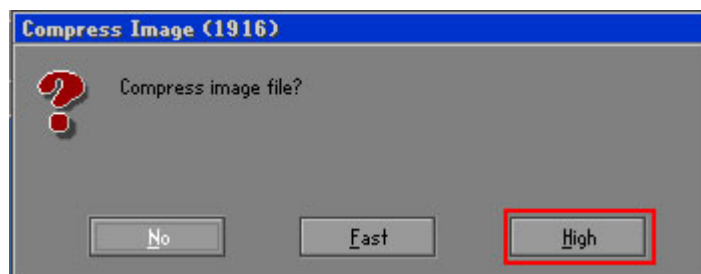

Figure B-17: Compress Image

Step 9: The Proceed with partition image creation window appears, click **Yes** to continue.

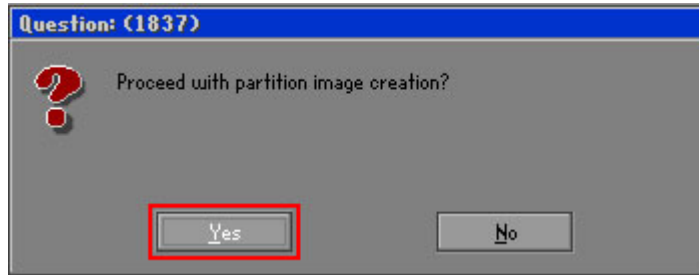

Figure B-18: Image Creation Confirmation

Step 10: The Symantec Ghost starts to create the factory default image (**Figure B-19**).

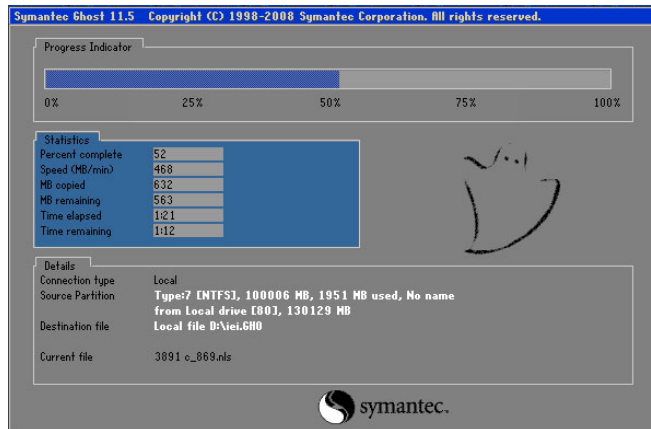

Figure B-19: Image Creation Complete

Step 11: When the image creation completes, a screen prompts as shown in **Figure B-20**.

Click **Continue** and close the Ghost window to exit the program.

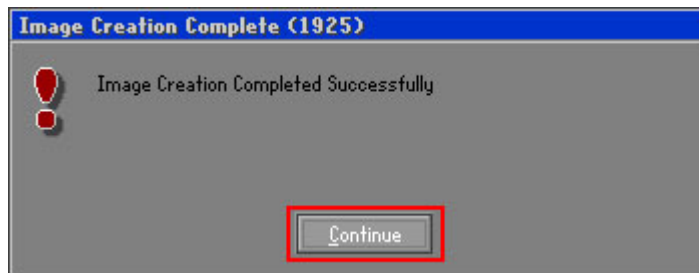
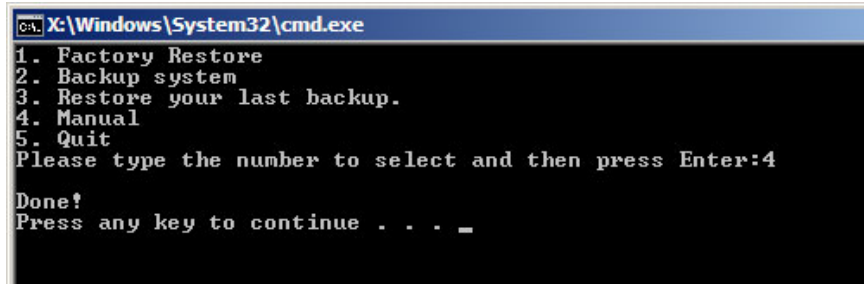

Figure B-20: Image Creation Complete

Step 12: The recovery tool main menu window is shown as below. Press any key to reboot the system.



```

C:\Windows\System32\cmd.exe
1. Factory Restore
2. Backup system
3. Restore your last backup.
4. Manual
5. Quit
Please type the number to select and then press Enter:4
Done!
Press any key to continue . . . _
  
```

Figure B-21: Press Any Key to Continue

B.3 Auto Recovery Setup Procedure

The auto recovery function allows a system to automatically restore from the factory default image after encountering a Blue Screen of Death (BSoD) or a hang for around 10 minutes. To use the auto recovery function, follow the steps described in the following sections.



CAUTION:

The auto recovery function can only run on a Microsoft Windows system with the following OS versions:

- Windows 2000
- Windows XP
- Windows Vista
- Windows 7
- Windows XP Embedded
- Windows Embedded Standard 7



CAUTION:

The setup procedure may include a step to create a factory default image. It is suggested to configure the system to a factory default environment before the configuration, including driver and application installations.

Step 1: Follow the steps described in **Section B.2.1 ~ Section B.2.3** to setup BIOS, create partitions and install operating system.

Step 2: Install the auto recovery utility into the system by double clicking the **Utility/AUTORECOVERY-SETUP.exe** in the One Key Recovery CD. This utility **MUST** be installed in the system, otherwise, the system will automatically restore from the factory default image every ten (10) minutes.



Figure B-22: Auto Recovery Utility

Step 3: **Disable the automatically restart function before creating the factory default image.** Go to: My Computer → Properties → Advanced. Click the Settings button of Startup and Recovery. Deselect “Automatically restart”. Click OK to save the settings and exit. (See Figure B-23)

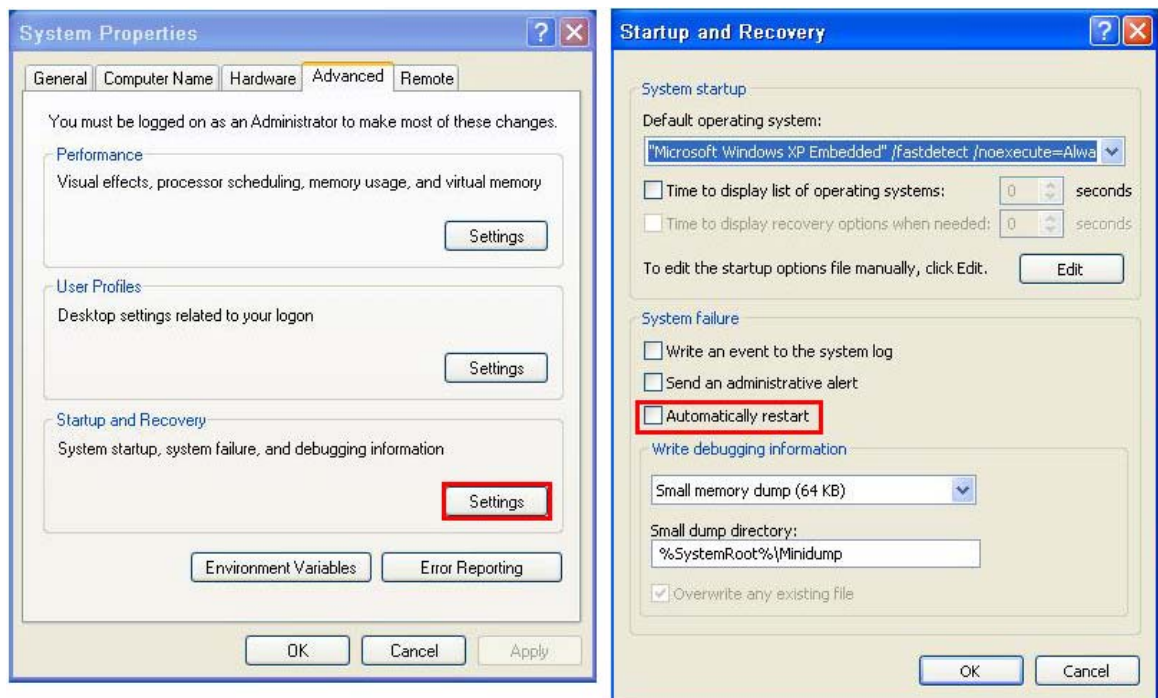

Figure B-23: Disable Automatically Restart

Step 4: Reboot the system from the recovery CD. When prompted, press any key to boot from the recovery CD. It will take a while to launch the recovery tool. Please be patient!

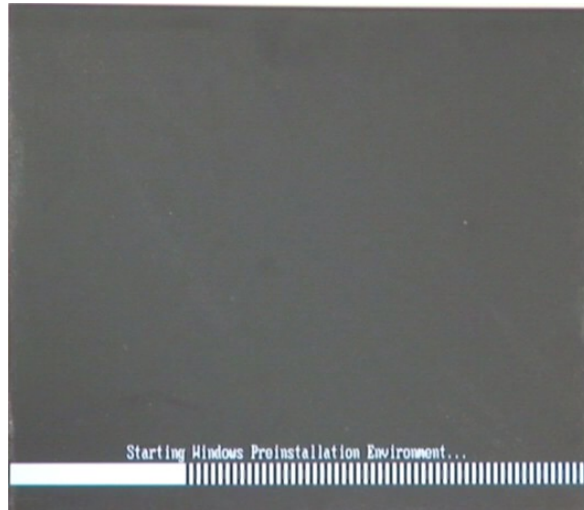

Figure B-24: Launching the Recovery Tool

Step 5: When the recovery tool setup menu appears, press <4> then <Enter>.

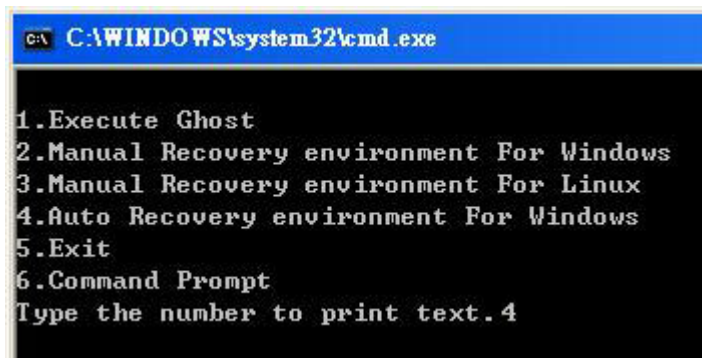

Figure B-25: Auto Recovery Environment for Windows

Step 6: The Symantec Ghost window appears and starts configuring the system to build an auto recovery partition. In this process the partition created for recovery files in **Section B.2.2** is hidden and the auto recovery tool is saved in this partition.

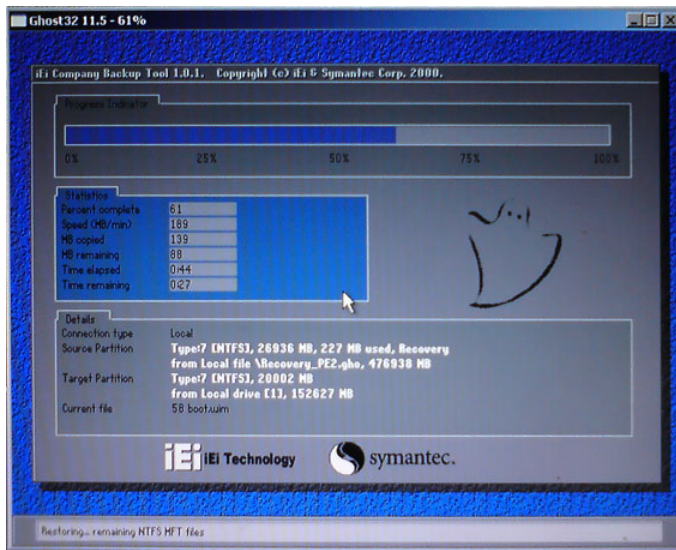

Figure B-26: Building the Auto Recovery Partition

Step 7: After completing the system configuration, the following message prompts to confirm whether to create a factory default image. Type **Y** to have the system create a factory default image automatically. Type **N** within 6 seconds to skip this process (The default option is YES). It is suggested to choose YES for this option.



Figure B-27: Factory Default Image Confirmation

Step 8: The Symantec Ghost starts to create the factory default image (**Figure B-28**).

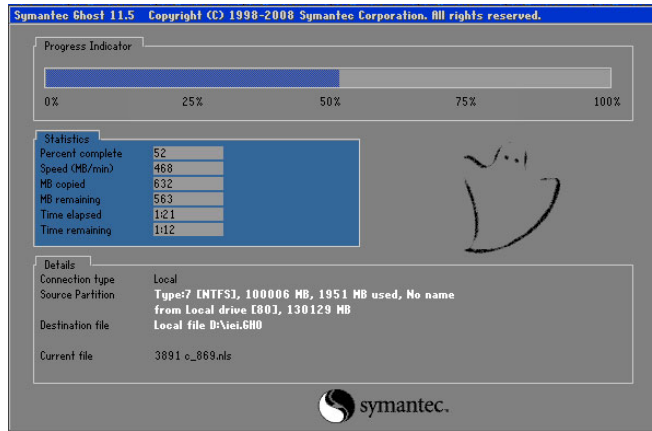

Figure B-28: Image Creation Complete

Step 9: After completing the system configuration, press any key in the following window to restart the system.

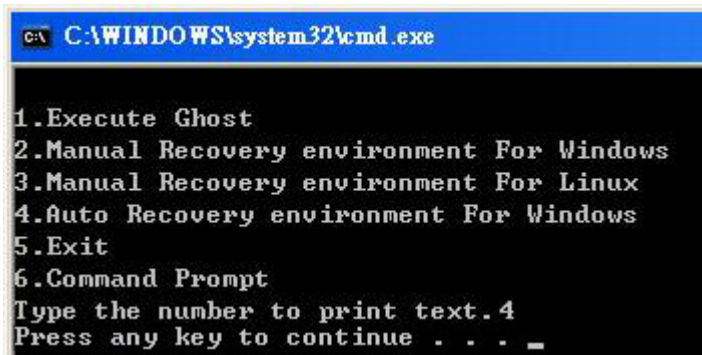
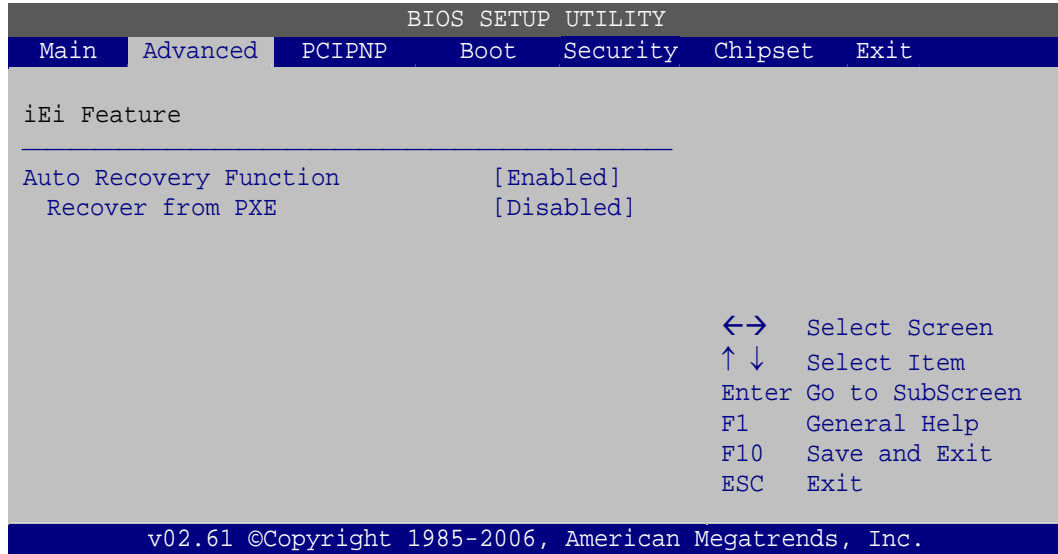

Figure B-29: Press any key to continue

Step 10: Eject the One Key Recovery CD and restart the system.

Step 11: Press the <DELETE> key as soon as the system is turned on to enter the BIOS.

Step 12: Enable the Auto Recovery Function option (**Advanced** → **iEi Feature** → **Auto Recovery Function**).



BIOS Menu 24: IEI Feature

Step 13: Save changes and restart the system. If the system encounters a Blue Screen of Death (BSoD) or a hang for around 10 minutes, it will automatically restore from the factory default image.

B.4 Setup Procedure for Linux

The initial setup procedure for Linux system is mostly the same with the procedure for Microsoft Windows. Please follow the steps below to setup recovery tool for Linux OS.

Step 1: Hardware and BIOS setup. Refer to **Section B.2.1**.

Step 2: Install Linux operating system. Make sure to install GRUB (v0.97 or earlier) MBR type and Ext3 partition type. Leave enough space on the hard drive to create the recover partition later.



NOTE:

If the Linux OS is not installed with GRUB (v0.97 or earlier) and Ext3, the Symantec Ghost may not function properly.

While installing Linux OS, please create two partitions:

- Partition 1: /
- Partition 2: SWAP



NOTE:

Please reserve enough space for partition 3 for saving recovery images.

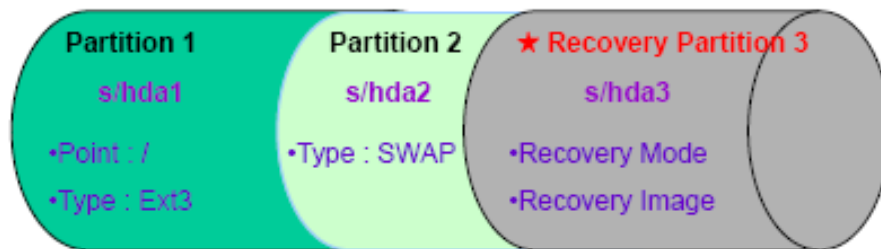

Figure B-30: Partitions for Linux

Step 3: Create a recovery partition. Insert the recovery CD into the optical disk drive.

Follow **Step 1 ~ Step 3** described in **Section B.2.2**. Then type the following commands (marked in red) to create a partition for recovery images.

```
system32>diskpart
DISKPART>list vol
DISKPART>sel disk 0
DISKPART>create part pri size= ____
DISKPART>assign letter=N
DISKPART>exit
system32>format N: /fs:ntfs /q /v:Recovery /y
system32>exit
```

Step 4: Build the recovery partition. Press any key to boot from the recovery CD. It will take a while to launch the recovery tool. Please be patient. When the recovery tool setup menu appears, type <3> and press <Enter> (**Figure B-31**). The Symantec Ghost window appears and starts configuring the system to build a

KINO-AH612

recovery partition. After completing the system configuration, press any key to reboot the system. Eject the recovery CD.

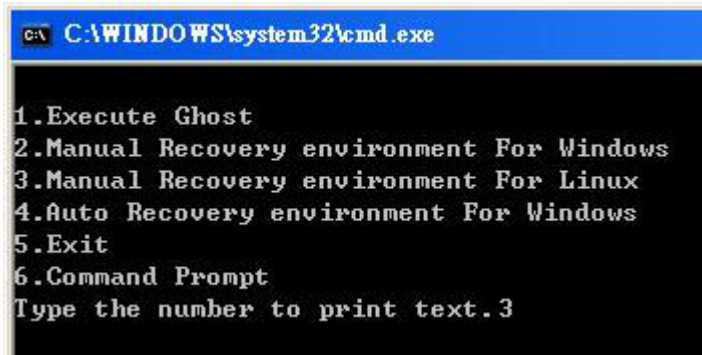

```
C:\WINDOWS\system32\cmd.exe

1.Execute Ghost
2.Manual Recovery environment For Windows
3.Manual Recovery environment For Linux
4.Auto Recovery environment For Windows
5.Exit
6.Command Prompt
Type the number to print text.3
```

Figure B-31: Manual Recovery Environment for Linux

Step 5: Access the recovery tool main menu by modifying the “menu.lst”. To first access the recovery tool main menu, the menu.lst must be modified. In Linux, enter Administrator (root). When prompt appears, type:

```
cd /boot/grub
```

```
vi menu.lst
```

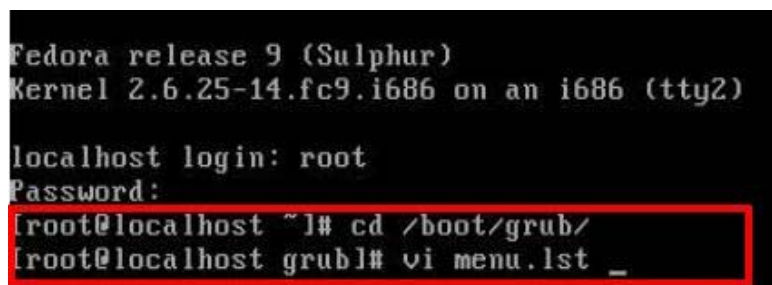

```
Fedora release 9 (Sulphur)
Kernel 2.6.25-14.fc9.i686 on an i686 (tty2)

localhost login: root
Password:
[root@localhost ~]# cd /boot/grub/
[root@localhost grub]# vi menu.lst _
```

Figure B-32: Access menu.lst in Linux (Text Mode)

Step 6: Modify the menu.lst as shown below.

```

#boot=/dev/sda
default=0
timeout=10 ← Modify timeout=10
splashimage=(hd0,0)/grub/splash.xpm.gz
hiddenmenu
title Fedora (2.6.25-14.fc9.i686)
    root (hd0,0)
    kernel /vmlinuz-2.6.25-14.fc9.i686 ro root=UUID=10f1acd
    ac38b5c78910 rhgb quiet
    initrd /initrd-2.6.25-14.fc9.i686.img

title Recovery Partition
    root (hd0,2)
    makeactive ← Type command
    chainloader +1
  
```

- Type command:
title Recovery Partition
root (hd0,2)
makeactive
chainloader +1

Step 7: The recovery tool menu appears. (Figure B-33)

```

1. Factory Restore
2. Backup system
3. Restore your last backup.
4. Manual
5. Quit
Please type the number to select and then press Enter:
  
```

Figure B-33: Recovery Tool Menu

Step 8: Create a factory default image. Follow **Step 2 ~ Step 12** described in **Section B.2.5** to create a factory default image.

B.5 Recovery Tool Functions

After completing the initial setup procedures as described above, users can access the recovery tool by pressing <F3> while booting up the system. However, if the setup procedure in Section B.3 has been completed and the auto recovery function is enabled, the system will automatically restore from the factory default image without pressing the F3 key. The recovery tool main menu is shown below.

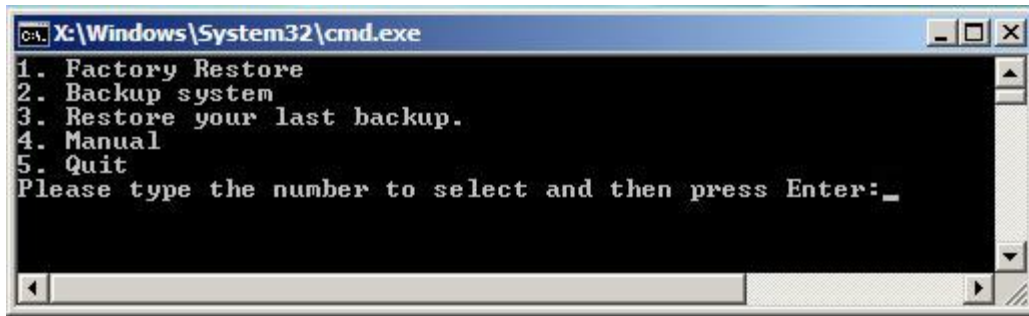

Figure B-34: Recovery Tool Main Menu

The recovery tool has several functions including:

1. **Factory Restore:** Restore the factory default image (iei.GHO) created in Section B.2.5.
2. **Backup system:** Create a system backup image (iei_user.GHO) which will be saved in the hidden partition.
3. **Restore your last backup:** Restore the last system backup image
4. **Manual:** Enter the Symantec Ghost window to configure manually.
5. **Quit:** Exit the recovery tool and restart the system.



WARNING:

Please do not turn off the system power during the process of system recovery or backup.



WARNING:

All data in the system will be deleted during the system recovery. Please backup the system files before restoring the system (either Factory Restore or Restore Backup).

B.5.1 Factory Restore

To restore the factory default image, please follow the steps below.

Step 1: Type <1> and press <Enter> in the main menu.

Step 2: The Symantec Ghost window appears and starts to restore the factory default. A factory default image called **iei.GHO** is created in the hidden Recovery partition.

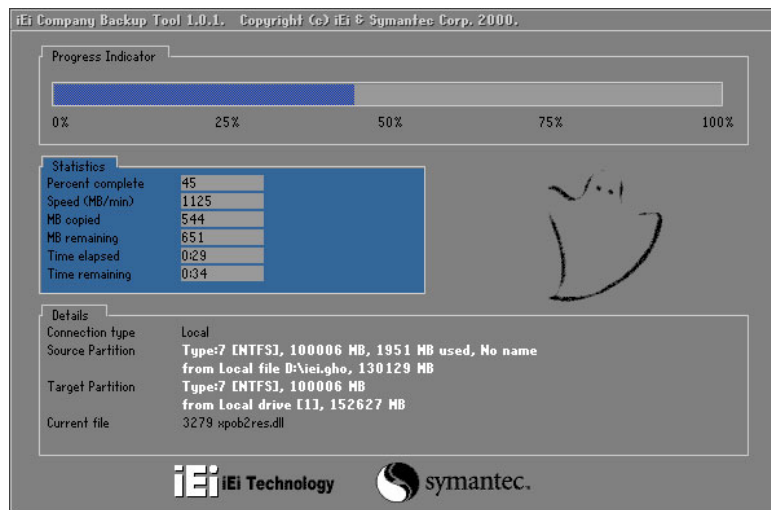

Figure B-35: Restore Factory Default

Step 3: The screen shown in **Figure B-36** appears when completed. Press any key to reboot the system.

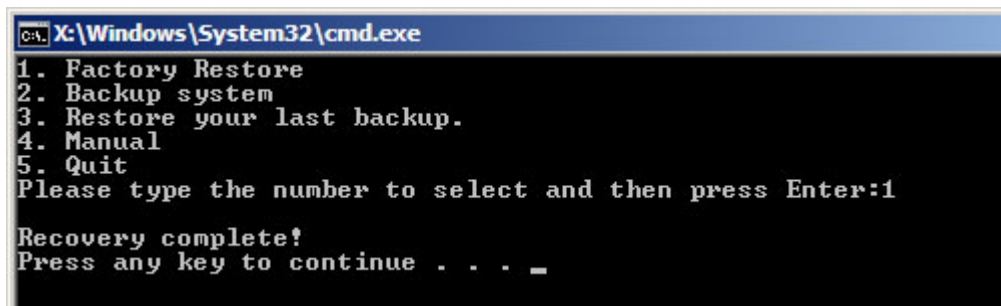

Figure B-36: Recovery Complete Window

B.5.2 Backup System

To backup the system, please follow the steps below.

Step 1: Type <2> and press <Enter> in the main menu.

Step 2: The Symantec Ghost window appears and starts to backup the system. A backup image called `iei_user.GHO` is created in the hidden Recovery partition.

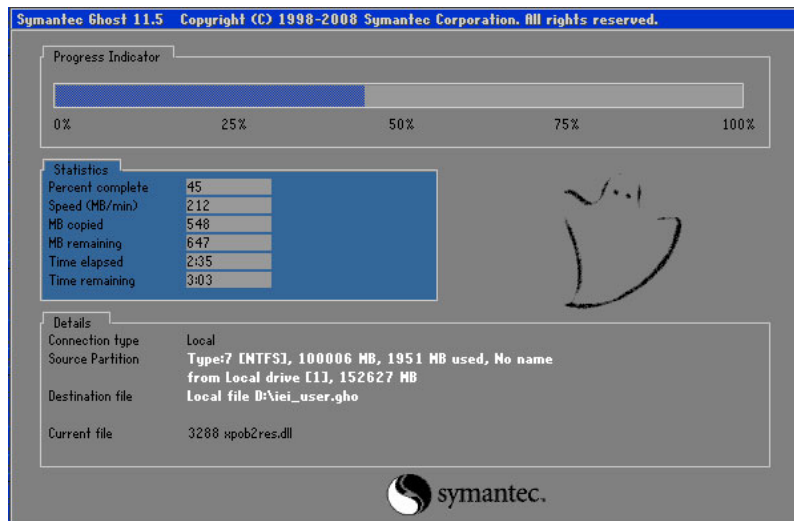

Figure B-37: Backup System

Step 3: The screen shown in **Figure B-38** appears when system backup is complete. Press any key to reboot the system.

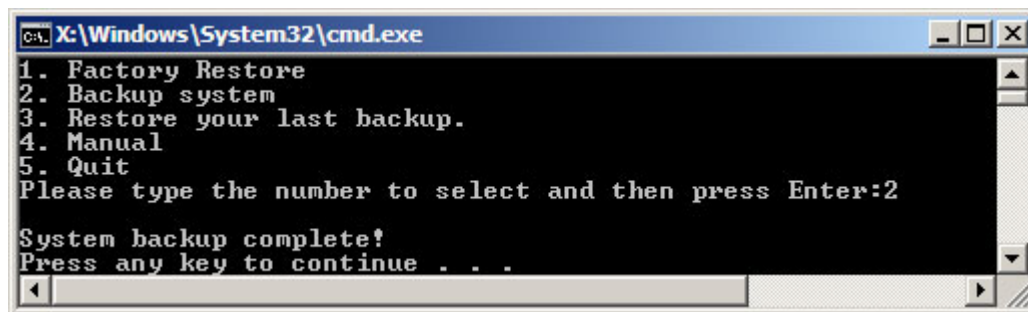

Figure B-38: System Backup Complete Window

B.5.3 Restore Your Last Backup

To restore the last system backup, please follow the steps below.

Step 1: Type <3> and press <Enter> in the main menu.

Step 2: The Symantec Ghost window appears and starts to restore the last backup image (iei_user.GHO).

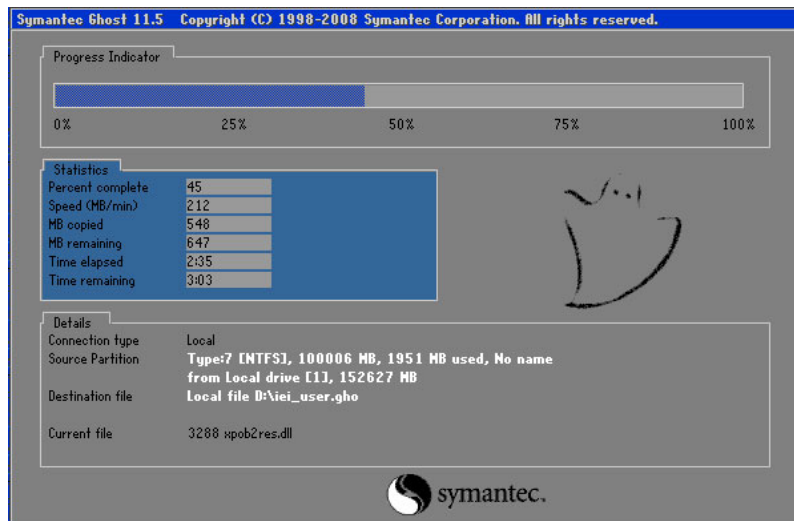

Figure B-39: Restore Backup

Step 3: The screen shown in **Figure B-40** appears when backup recovery is complete. Press any key to reboot the system.

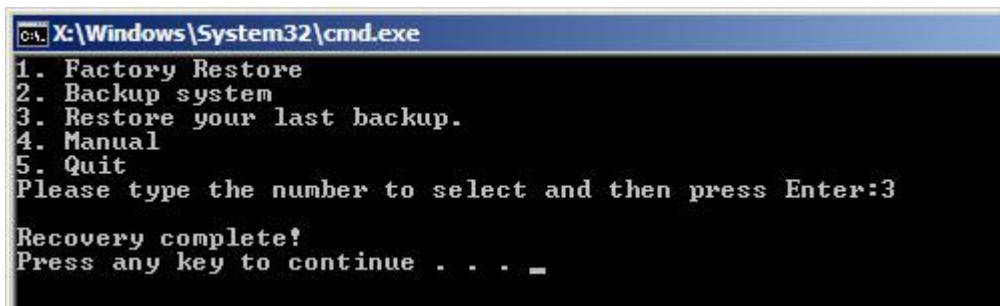

Figure B-40: Restore System Backup Complete Window

KINO-AH612

B.5.4 Manual

To restore the last system backup, please follow the steps below.

Step 1: Type <4> and press <Enter> in the main menu.

Step 2: The Symantec Ghost window appears. Use the Ghost program to backup or recover the system manually.

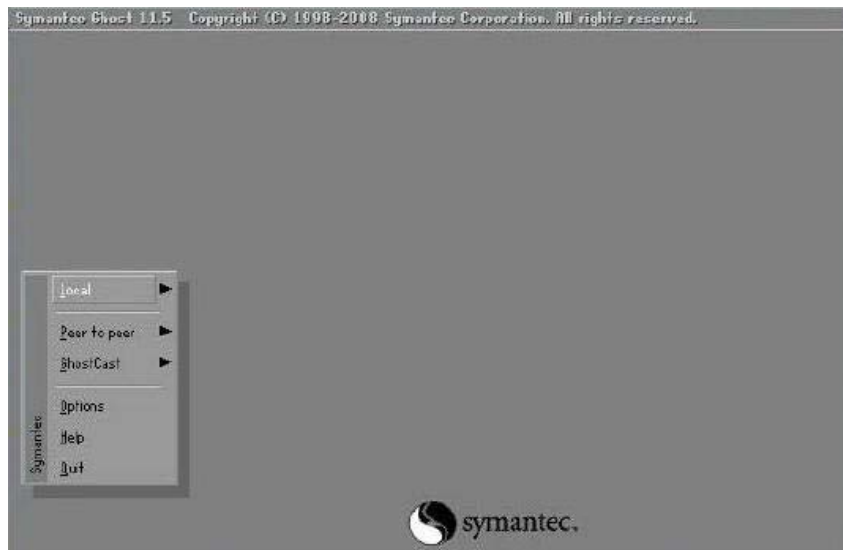
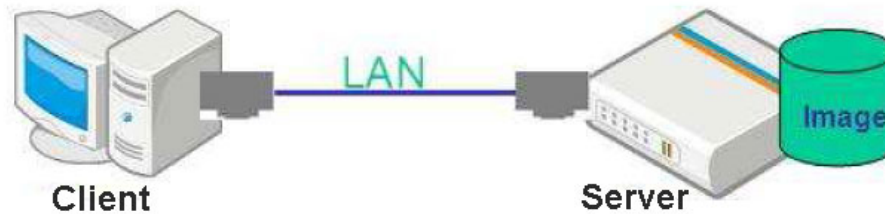

Figure B-41: Symantec Ghost Window

Step 3: When backup or recovery is completed, press any key to reboot the system.

B.6 Restore Systems from a Linux Server through LAN

The One Key Recovery allows a client system to automatically restore to a factory default image saved in a Linux system (the server) through LAN connectivity after encountering a Blue Screen of Death (BSoD) or a hang for around 10 minutes. To be able to use this function, the client system and the Linux system MUST reside in the same domain.



CAUTION:

The supported client OS includes:

- Windows 2000
- Windows XP
- Windows Vista
- Windows 7
- Windows XP Embedded
- Windows Embedded Standard 7

Prior to restoring client systems from a Linux server, a few setup procedures are required.

Step 1: Configure DHCP server settings

Step 2: Configure TFTP settings

Step 3: Configure One Key Recovery server settings

Step 4: Start DHCP, TFTP and HTTP

Step 5: Create a shared directory

Step 6: Setup a client system for auto recovery

The detailed descriptions are described in the following sections. In this document, two types of Linux OS are used as examples to explain the configuration process – CentOS 5.5 (Kernel 2.6.18) and Debian 5.0.7 (Kernel 2.6.26).

B.6.1 Configure DHCP Server Settings

Step 1: Install the DHCP

`#yum install dhcp` (CentOS, commands marked in red)

`#apt-get install dhcp3-server` (Debian, commands marked in blue)

Step 2: Confirm the operating system default settings: dhcpd.conf.

CentOS

Use the following command to show the DHCP server sample location:

`#vi /etc/dhcpd.conf`

The DHCP server sample location is shown as below:

```
# DHCP Server Configuration file.
# see /usr/share/doc/dhcp*/dhcpd.conf.sample
```

Use the following command to copy the DHCP server sample to etc/dhcpd.conf:

`#cp /usr/share/doc/dhcp-3.0.5/dhcpd.conf.sample /etc/dhcpd.conf`

`#vi /etc/dhcpd.conf`

```
ddns-update-style interim;
ignore client-updates;

subnet 192.168.0.0 netmask 255.255.255.0 {
# --- default gateway
    option routers                192.168.0.2;
    option subnet-mask            255.255.255.0;

    option nis-domain             "domain.org";
    option domain-name            "domain.org";
    option domain-name-servers   192.168.0.1;
    next-server 192.168.0.6;
    filename "pxelinux.0";
    option time-offset            -18000; # Eastern Standard Time
    option ntp-servers            192.168.1.1;
}
```

Debian

`#vi /etc/dhcpd.conf`

Edit “/etc/dhcpd.conf” for your environment. For example, add

`next-server PXE server IP address;`

```
filename "pxelinux.0";
```

```
ddns-update-style interim;
ignore client-updates;

subnet 192.168.0.0 netmask 255.255.255.0 {
# --- default gateway
option routers 192.168.0.2;
option subnet-mask 255.255.255.0;

option nis-domain "domain.org";
option domain-name "domain.org";
option domain-name-servers 192.168.0.1;
next-server 192.168.0.6;
filename "pxelinux.0";
option time-offset -18000; # Eastern Standard Time
option ntp-servers 192.168.1.1;
}
```

B.6.2 Configure TFTP Settings

Step 1: Install the tftp, httpd and syslinux.

```
#yum install tftp-server httpd syslinux (CentOS)
```

```
#apt-get install tftpd-hpa xinetd syslinux (Debian)
```

Step 2: Enable the TFTP server by editing the "/etc/xinetd.d/tftp" file and make it use the remap file. The "-vvv" is optional but it could definitely help on getting more information while running the remap file. For example:

CentOS

```
#vi /etc/xinetd.d/tftp
```

Modify:

```
disable = no
```

```
server_args = -s /tftpboot -m /tftpboot/tftpd.remap -vvv_
```

```
socket_type      = dgram
protocol        = udp
wait            = yes
user            = root
server          = /usr/sbin/in.tftpd
server_args     = -s /tftpboot -m /tftpboot/tftpd.remap -vvv
disable         = no
per_source      = 11
cps             = 100 2
flags           = IPv4
```

Debian

Replace the TFTP settings from “inetd” to “xinetd” and annotate the “inetd” by adding “#”.

`#vi /etc/inetd.conf`

Modify: `#tftp dgram udp wait root /usr/sbin.....` (as shown below)

```
#:BOOT: TFTP service is provided primarily for booting. Most sites
# run this only on machines acting as "boot servers."
#tftp dgram udp wait root /usr/sbin/in.tftpd /usr/sbin/in.tftpd -s
/var/lib/tftpboot
```

`#vi /etc/xinetd.d/tftp`

```
socket_type      = dgram
protocol        = udp
wait            = yes
user            = root
server          = /usr/sbin/in.tftpd
server_args     = -s /tftpboot -n /tftpboot/tftpd.remap -vvv
disable         = no
per_source      = 11
cps             = 100 2
flags           = IPv4
```

B.6.3 Configure One Key Recovery Server Settings

Step 1: Copy the **Utility/RECOVERYR10.TAR.BZ2** package from the One Key Recovery CD to the system (server side).



Step 2: Extract the recovery package to /.

```
#cp RecoveryR10.tar.bz2 /
#cd /
#tar -xvjf RecoveryR10.tar.bz2
```

Step 3: Copy “pxelinux.0” from “syslinux” and install to “/tftpboot”.

```
#cp /usr/lib/syslinux/pxelinux.0 /tftpboot/
```

B.6.4 Start the DHCP, TFTP and HTTP

Start the DHCP, TFTP and HTTP. For example:

CentOS

```
#service xinetd restart
```

```
#service httpd restart
```

```
#service dhcpd restart
```

Debian

```
#/etc/init.d/xinetd reload
```

```
#/etc/init.d/xinetd restart
```

```
#/etc/init.d/dhcp3-server restart
```

B.6.5 Create Shared Directory

Step 1: Install the samba.

```
#yum install samba
```

Step 2: Create a shared directory for the factory default image.

```
#mkdir /share
```

```
#cd /share
```

```
#mkdir /image
```

```
#cp iei.gho /image
```



WARNING:

The file name of the factory default image must be **iei.gho**.

KINO-AH612

Step 3: Confirm the operating system default settings: smb.conf.

```
#vi /etc/samba/smb.conf
```

Modify:

```
[image]
```

```
comment = One Key Recovery
```

```
path = /share/image
```

```
browseable = yes
```

```
writable = yes
```

```
public = yes
```

```
create mask = 0644
```

```
directory mask = 0755
```

Step 4: Edit “/etc/samba/smb.conf” for your environment. For example:

```
# "security = user" is always a good idea. This will require a Unix account
# in this server for every user accessing the server. See
# /usr/share/doc/samba-doc/htmldocs/Samba3-HOWTO/ServerType.html
# in the samba-doc package for details.
security = share
```

```
[image]
comment = One Key Recovery
path = /share/image
browseable = yes
writable = yes
public = yes
create mask = 0644
directory mask = 0755
```

Step 5: Modify the hostname

```
#vi /etc/hostname
```

Modify: RecoveryServer

```
RecoveryServer
```

B.6.6 Setup a Client System for Auto Recovery

Step 1: Disable the automatically restart function before creating the factory default image. Go to: My Computer → Properties → Advanced. Click the

Settings button of Startup and Recovery. Deselect “Automatically restart”. Click OK to save the settings and exit. (See Figure B-23)

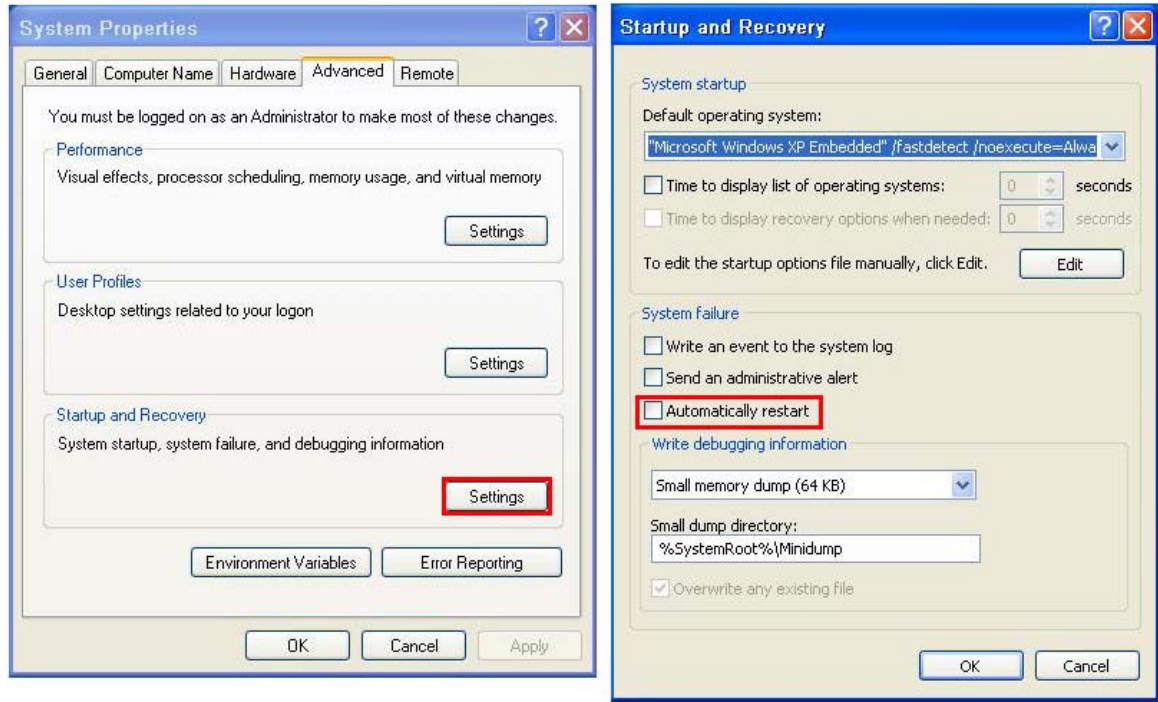

Figure B-42: Disable Automatically Restart

Step 2: Configure the following BIOS options of the client system.

Advanced → iEi Feature → Auto Recovery Function → **Enabled**

Advanced → iEi Feature → Recover from PXE → **Enabled**

Boot → Launch PXE OpROM → **Enabled**

Step 3: Continue to configure the **Boot Option Priorities** BIOS option of the client system:

Boot Option #1 → remain the default setting to boot from the original OS.

Boot Option #2 → select the boot from LAN option.

Step 4: Save changes and exit BIOS menu.

Exit → **Save Changes and Exit**

KINO-AH612

Step 5: Install the auto recovery utility into the system by double clicking the **Utility/AUTORECOVERY-SETUP.exe** in the One Key Recovery CD. This utility **MUST** be installed in the system, otherwise, the system will automatically restore from the factory default image every ten (10) minutes.



Step 6: Restart the client system from LAN. If the system encounters a Blue Screen of Death (BSoD) or a hang for around 10 minutes, it will automatically restore from the factory default image. The following screens will show when the system starts auto recovering.

```
Realtek PCIe GBE Family Controller Series v2.35 (06/14/10)
CLIENT MAC ADDR: 00 18 7D 13 E6 89  GUID: 00020003-0004-0005-0006-0007000000
DHCP.._
```

```
My IP address seems to be C0A80009 192.168.0.9
ip=192.168.0.9:192.168.0.8:192.168.0.2:255.255.255.0
TFTP prefix:
Trying to load: pxelinux.cfg/00020003-0004-0005-0006-000700000009
Trying to load: pxelinux.cfg/01-00-18-7d-13-e6-89
Trying to load: pxelinux.cfg/C0A80009
Trying to load: pxelinux.cfg/C0A8000
Trying to load: pxelinux.cfg/C0A800
Trying to load: pxelinux.cfg/C0A80
Trying to load: pxelinux.cfg/C0A8
Trying to load: pxelinux.cfg/C0A
Trying to load: pxelinux.cfg/C0
Trying to load: pxelinux.cfg/C
Trying to load: pxelinux.cfg/default
boot:
```

```
Windows is loading files...
IP: 192.168.0.8, File: \Boot\WinPE.wim
```

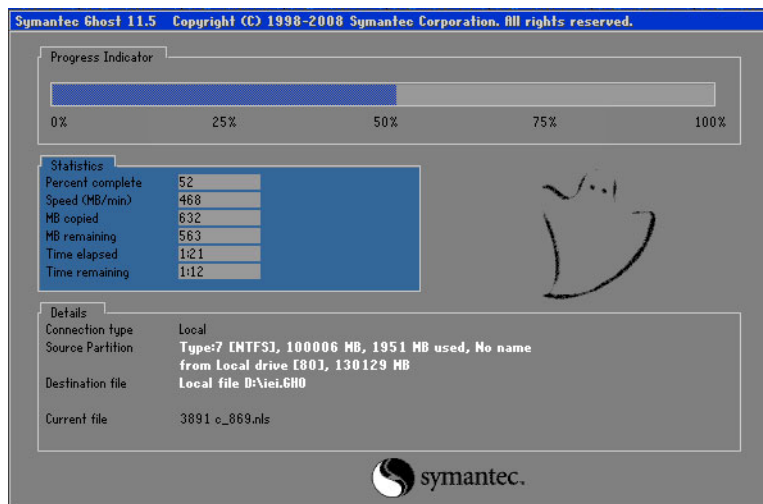
NOTE:

A firewall or a SELinux is not in use in the whole setup process described above. If there is a firewall or a SELinux protecting the system, modify the configuration information to accommodate them.

B.7 Other Information

B.7.1 Using AHCI Mode or ALi M5283 / VIA VT6421A Controller

When the system uses AHCI mode or some specific SATA controllers such as ALi M5283 or VIA VT6421A, the SATA RAID/AHCI driver must be installed before using one key recovery. Please follow the steps below to install the SATA RAID/AHCI driver.

- Step 1:** Copy the SATA RAID/AHCI driver to a floppy disk and insert the floppy disk into a USB floppy disk drive. The SATA RAID/AHCI driver must be especially designed for the on-board SATA controller.
- Step 2:** Connect the USB floppy disk drive to the system.
- Step 3:** Insert the One Key Recovery CD into the system and boot the system from the CD.
- Step 4:** When launching the recovery tool, press <F6>.

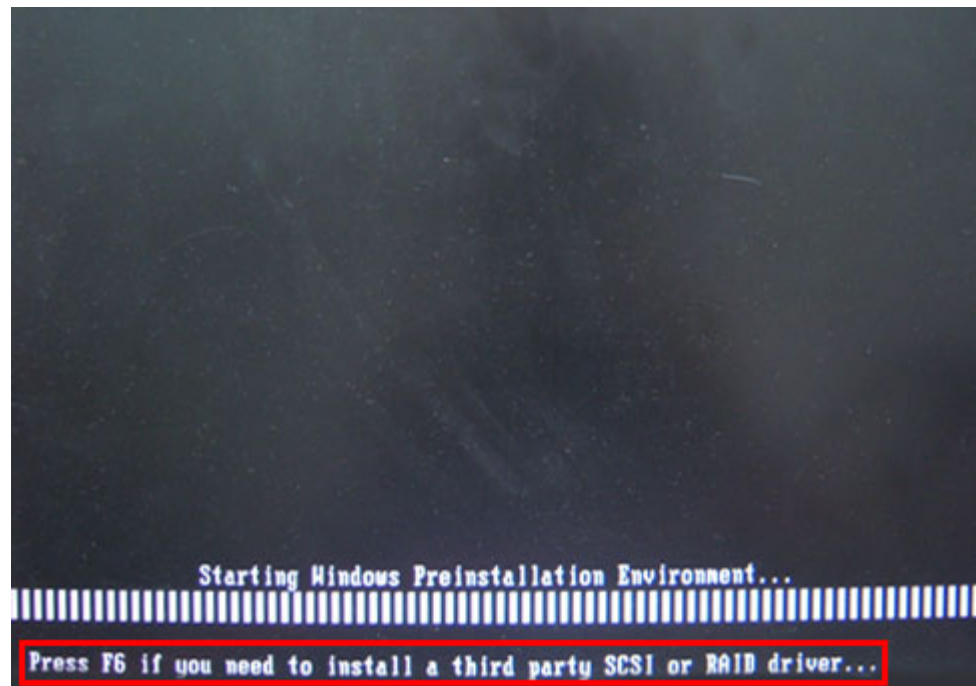

Step 5: When the following window appears, press <S> to select "Specify Additional Device".

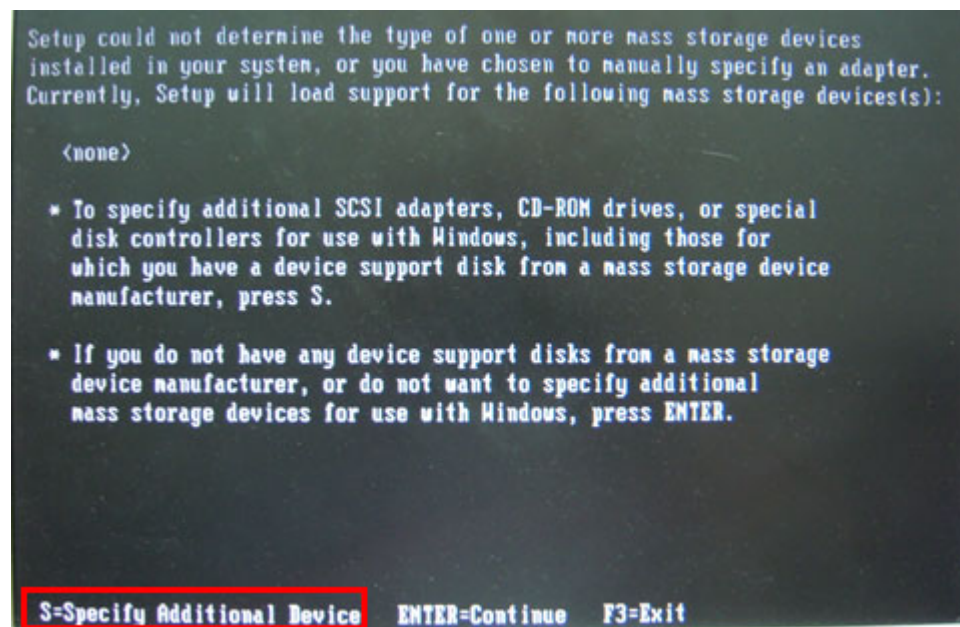

Step 6: In the following window, select a SATA controller mode used in the system. Then press <Enter>. The user can now start using the SATA HDD.

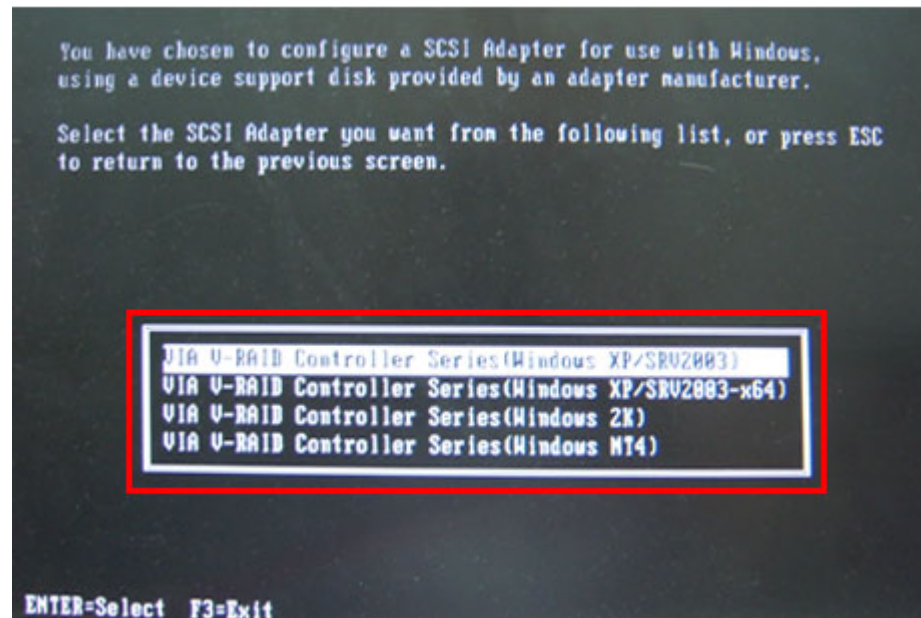

Step 7: After pressing <Enter>, the system will get into the recovery tool setup menu. Continue to follow the setup procedure from **Step 4** in **Section B.2.2 Create Partitions** to finish the whole setup process.

B.7.2 System Memory Requirement

To be able to access the recovery tool by pressing <F3> while booting up the system, please make sure to have enough system memory. The minimum memory requirement is listed below.

- **Using Award BIOS:** 128 MB system memory
- **Using AMI BIOS:** 512 MB system memory.

Appendix

C

Terminology

AC '97	Audio Codec 97 (AC'97) refers to a codec standard developed by Intel® in 1997.
ACPI	Advanced Configuration and Power Interface (ACPI) is an OS-directed configuration, power management, and thermal management interface.
AHCI	Advanced Host Controller Interface (AHCI) is a SATA Host controller register-level interface.
ATA	The Advanced Technology Attachment (ATA) interface connects storage devices including hard disks and CD-ROM drives to a computer.
APM	The Advanced Power Management (APM) application program interface (API) enables the inclusion of power management in the BIOS.
ARMD	An ATAPI Removable Media Device (ARMD) is any ATAPI device that supports removable media, besides CD and DVD drives.
ASKIR	Amplitude Shift Keyed Infrared (ASKIR) is a form of modulation that represents a digital signal by varying the amplitude (“volume”) of the signal. A low amplitude signal represents a binary 0, while a high amplitude signal represents a binary 1.
BIOS	The Basic Input/Output System (BIOS) is firmware that is first run when the computer is turned on and can be configured by the end user
CODEC	The Compressor-Decompressor (CODEC) encodes and decodes digital audio data on the system.
CMOS	Complimentary metal-oxide-conductor is a type of integrated circuit used in chips like static RAM and microprocessors.
COM	COM is used to refer to serial ports. Serial ports offer serial communication to expansion devices. The serial port on a personal

KINO-AH612

	computer is usually a male DE-9 connector.
DAC	The Digital-to-Analog Converter (DAC) converts digital signals to analog signals.
DDR	Double Data Rate refers to a data bus transferring data on both the rising and falling edges of the clock signal.
DMA	Direct Memory Access (DMA) enables some peripheral devices to bypass the system processor and communicate directly with the system memory.
DIMM	Dual Inline Memory Modules are a type of RAM that offer a 64-bit data bus and have separate electrical contacts on each side of the module.
EHCI	The Enhanced Host Controller Interface (EHCI) specification is a register-level interface description for USB 2.0 Host Controllers.
GbE	Gigabit Ethernet (GbE) is an Ethernet version that transfers data at 1.0 Gbps and complies with the IEEE 802.3-2005 standard.
GPIO	General purpose input
IrDA	Infrared Data Association (IrDA) specify infrared data transmission protocols used to enable electronic devices to wirelessly communicate with each other.
L1 Cache	The Level 1 Cache (L1 Cache) is a small memory cache built into the system processor.
L2 Cache	The Level 2 Cache (L2 Cache) is an external processor memory cache.
LVDS	Low-voltage differential signaling (LVDS) is a dual-wire, high-speed differential electrical signaling system commonly used to connect LCD displays to a computer.
MAC	The Media Access Control (MAC) protocol enables several terminals or network nodes to communicate in a LAN, or other multipoint networks.

PCIe	PCI Express (PCIe) is a communications bus that uses dual data lines for full-duplex (two-way) serial (point-to-point) communications between the SBC components and/or expansion cards and the SBC chipsets. Each line has a 2.5 Gbps data transmission rate and a 250 MBps sustained data transfer rate.
POST	The Power-on Self Test (POST) is the pre-boot actions the system performs when the system is turned-on.
QVGA	Quarter Video Graphics Array (QVGA) refers to a display with a resolution of 320 x 240 pixels.
RAM	Random Access Memory (RAM) is a form of storage used in computer. RAM is volatile memory, so it loses its data when power is lost. RAM has very fast data transfer rates compared to other storage like hard drives.
SATA	Serial ATA (SATA) is a serial communications bus designed for data transfers between storage devices and the computer chipsets. The SATA bus has transfer speeds up to 1.5 Gbps and the SATA 3Gb/s bus has data transfer speeds of up to 3.0 Gbps.
S.M.A.R.T	Self Monitoring Analysis and Reporting Technology (S.M.A.R.T) refers to automatic status checking technology implemented on hard disk drives.
UART	Universal Asynchronous Receiver-transmitter (UART) is responsible for asynchronous communications on the system and manages the system's serial communication (COM) ports.
UHCI	The Universal Host Controller Interface (UHCI) specification is a register-level interface description for USB 1.1 Host Controllers.
USB	The Universal Serial Bus (USB) is an external bus standard for interfacing devices. USB 1.1 supports 12Mbps data transfer rates, while

KINO-AH612

USB 2.0 supports 480Mbps data transfer rates.

VGA

The Video Graphics Array (VGA) is a graphics display system developed by IBM.

Appendix

D

Watchdog Timer



NOTE:

The following discussion applies to DOS environment. IEI support is contacted or the IEI website visited for specific drivers for more sophisticated operating systems, e.g., Windows and Linux.

The Watchdog Timer is provided to ensure that standalone systems can always recover from catastrophic conditions that cause the CPU to crash. This condition may have occurred by external EMI or a software bug. When the CPU stops working correctly, Watchdog Timer either performs a hardware reset (cold boot) or a Non-Maskable Interrupt (NMI) to bring the system back to a known state.

A BIOS function call (INT 15H) is used to control the Watchdog Timer:

INT 15H:

AH – 6FH Sub-function:	
AL – 2:	Sets the Watchdog Timer's period.
BL:	Time-out value (Its unit-second is dependent on the item "Watchdog Timer unit select" in CMOS setup).

Table D-1: AH-6FH Sub-function

Call sub-function 2 to set the time-out period of Watchdog Timer first. If the time-out value is not zero, the Watchdog Timer starts counting down. While the timer value reaches zero, the system resets. To ensure that this reset condition does not occur, calling sub-function 2 must periodically refresh the Watchdog Timer. However, the Watchdog timer is disabled if the time-out value is set to zero.

A tolerance of at least 10% must be maintained to avoid unknown routines within the operating system (DOS), such as disk I/O that can be very time-consuming.

NOTE:

When exiting a program it is necessary to disable the Watchdog Timer, otherwise the system resets.

Example program:

```

; INITIAL TIMER PERIOD COUNTER
;
W_LOOP:

    MOV     AX, 6F02H    ;setting the time-out value
    MOV     BL, 30H      ;time-out value is 48 seconds
    INT     15H

;
; ADD THE APPLICATION PROGRAM HERE
;

    CMP     EXIT_AP, 1    ;is the application over?
    JNE     W_LOOP       ;No, restart the application

    MOV     AX, 6F02H    ;disable Watchdog Timer
    MOV     BL, 0        ;
    INT     15H

;
; EXIT ;
  
```

Appendix

E

Hazardous Materials Disclosure

E.1 Hazardous Material Disclosure Table for IPB Products Certified as RoHS Compliant Under 2002/95/EC Without Mercury

The details provided in this appendix are to ensure that the product is compliant with the Peoples Republic of China (China) RoHS standards. The table below acknowledges the presences of small quantities of certain materials in the product, and is applicable to China RoHS only.

A label will be placed on each product to indicate the estimated “Environmentally Friendly Use Period” (EFUP). This is an estimate of the number of years that these substances would “not leak out or undergo abrupt change.” This product may contain replaceable sub-assemblies/components which have a shorter EFUP such as batteries and lamps. These components will be separately marked.

Please refer to the table on the next page.

Part Name	Toxic or Hazardous Substances and Elements					
	Lead (Pb)	Mercury (Hg)	Cadmium (Cd)	Hexavalent Chromium (CR(VI))	Polybrominated Biphenyls (PBB)	Polybrominated Diphenyl Ethers (PBDE)
Housing	X	O	O	O	O	X
Display	X	O	O	O	O	X
Printed Circuit Board	X	O	O	O	O	X
Metal Fasteners	X	O	O	O	O	O
Cable Assembly	X	O	O	O	O	X
Fan Assembly	X	O	O	O	O	X
Power Supply Assemblies	X	O	O	O	O	X
Battery	O	O	O	O	O	O

O: This toxic or hazardous substance is contained in all of the homogeneous materials for the part is below the limit requirement in SJ/T11363-2006

X: This toxic or hazardous substance is contained in at least one of the homogeneous materials for this part is above the limit requirement in SJ/T11363-2006

此附件旨在确保本产品符合中国 RoHS 标准。以下表格标示此产品中某有毒物质的含量符合中国 RoHS 标准规定的限量要求。

本产品上会附有“环境友好使用期限”的标签，此期限是估算这些物质“不会有泄漏或突变”的年限。本产品可能包含有较短的环境友好使用期限的可替换元件，像是电池或灯管，这些元件将会单独标示出来。

部件名称	有毒有害物质或元素					
	铅 (Pb)	汞 (Hg)	镉 (Cd)	六价铬 (CR(VI))	多溴联苯 (PBB)	多溴二苯醚 (PBDE)
壳体	X	○	○	○	○	X
显示	X	○	○	○	○	X
印刷电路板	X	○	○	○	○	X
金属螺帽	X	○	○	○	○	○
电缆组装	X	○	○	○	○	X
风扇组装	X	○	○	○	○	X
电力供应组装	X	○	○	○	○	X
电池	○	○	○	○	○	○

○: 表示该有毒有害物质在该部件所有物质材料中的含量均在 SJ/T11363-2006 标准规定的限量要求以下。

X: 表示该有毒有害物质至少在该部件的某一均质材料中的含量超出 SJ/T11363-2006 标准规定的限量要求。